

Flow Transmitter / Screw Volumeter LABO-VHS-I / U / F / C



- Measures and monitors viscous media (oil) 1.4..2500 l/min
- Connection G 1..G 2¹/₂
- Very low dependence on viscosity
- Can be used up to 40,000 mm²/s (cSt)
- 0..10 V, 4..20 mA, frequency/pulse output, completely configurable
- Light and compact device (aluminium housing)
- Operation and measurement possible with forward and reverse flow
- For cost-sensitive applications

Characteristics

The VHS flow transmitter measures the flow using the volumetric principle, and is suitable for fluid, viscous, lubricant media (e.g. lubricating oil). If the material for the VHS is selected appropriately, aqueous fluids such as soaps, pastes, and emulsions with non-abrasive characteristics can also be measured, as long as they have sufficient lubricity. Because of the volumetric functioning principle, the device is almost completely independent of viscosity.

The VHS system consists of two interlacing screws which run in opposite directions, driven by the flowing medium. A magnetically pre-tensioned Hall sensor positioned outside the flow space detects the screw flanks, and creates a frequency signal proportional to the flow. Here, every pulse corresponds to a specific measured volume. There are no magnets in the flow space.

The LABO-XXX-I/U/F/C electronics make various output signals available:

- Analog signal 0/4...200 mA (LABO-VHS-I)
- Analog signal 0/2..10 V (LABO-VHS-U)
- Frequency signal (LABO-VHS-F) or
- Value signal Pulse / x Litres (LABO-VHS-C)

A model with switching output is also available (see separate datasheet). If desired, the range end value can be set to the currently existing flow using "teaching".

Technical data

Sensor	screw volumeter		
Nominal width	DN 25..65		
Process connection	female thread G 1..G 2 ¹ / ₂		
Metering ranges	see table "Ranges and weights"		
Measurement accuracy	±1 % of the measured value (at 20 mm ² /s, (cSt) of 1 %..100 % nominal working range (see also diagrams in upstream pages)		
Repeatability	±0,25 %		
Pressure resistance	Connection	SAE flange	PN bar
	Construction material		
	Aluminium	without	160
	Aluminium	with	350
	Steel	without	350
	Steel	with	350
	others available on request		
Pressure loss	see diagram in upstream pages		
Medium	oil or non-aggressive, self-lubricating fluids		
Medium temperature	-25..+80 °C (150 °C available on request)		
Materials medium-contact	(special materials available on request):		
1. Body	Aluminium 6082 anodised		
2. Connections:	Aluminium 6082 anodised or steel		
3. Main screw	Stahl 35SMnPb10 UNI 4838-80		
4. Subsidiary screw	GHISA GJL-250 EN1561		
5. Ball bearing	Steel		
6. Ball bearing	Steel		
7. Screws	Galvanised steel		
8. O-ring	NBR		
9. Seeger ring	Steel		
10. Seeger ring	Steel		
11. O-ring	NBR		
12. SAE connection	ASTM A216WCB		
13. SAE flange	ASTM A216WCB		
14. O-ring	NBR		
15. Screws	Galvanised steel		
16. Sensor spacer	Aluminium 6082 anodised		
Materials, non-medium-contact	Sensor tube:	CW614N nickelled	
	Adhesive:	epoxy resin	
	Flange bolts:	stainless steel	
Supply voltage	10..30 V DC at voltage output 10 V: 15..30 V DC		
Power consumption	< 1 W (for no-load outputs)		

Produktinformation

Output data:	all outputs are resistant to short circuits and reversal polarity protected
Current output:	4..20 mA (0..20 mA available on request)
Voltage output:	0..10 V (2..10 V available on request) output current max. 20 mA
Frequency output:	transistor output "push-pull" $I_{out} = 100$ mA max.
Pulse output:	transistor output "push-pull" $I_{out} = 100$ mA max. Pulse width 50 ms Pulse per volume is to be stated
Display	yellow LCD shows operating voltage (LABO-VHS-I / U) or output status (LABO-VHS-F / C) or (rapid flashing = programming)
Electrical connection	for round plug connector M12x1, 4-pole
Ingress protection	IP 67
Weight	see table "Ranges and weights"
Conformity	CE

Signal output curves

Value x = Begin of the specified range

 = not specified range

Current output

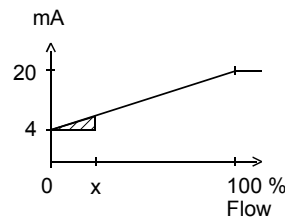

Voltage output

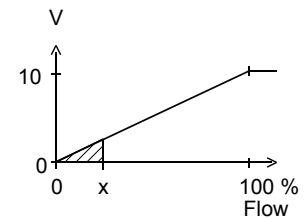

Frequency output

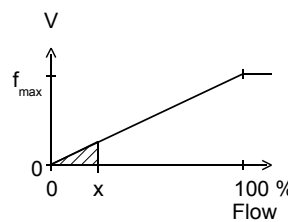

f_{max} selectable in the range of up to 2000 Hz

Other characters on request.

Ranges and weights

● = Standard ○ = Option

G	DN		Metering range 1..100 % Q_{nom}	Volume / pulse	Types	Q_{max} recommended	Weights		
							Body with aluminium connections	Body with steel connections	SAE Flanges (Weight per pair)
			l/min	cm ³		l/min	kg	kg	kg
G 1	DN 25	●	1.4.. 140	13.10	LABO-VHS-025...0140	200	3.44	4.76	5.76
G 1 1/4	DN 32	●	3.5.. 350	29.00	LABO-VHS-032...0350	500	6.35	8.50	9.55
G 1 1/2	DN 40	○	5.5.. 550	48.58	LABO-VHS-040...0550	800	10.50	13.60	15.10
		●	8.0.. 800	72.00	LABO-VHS-040...0800	1200	14.20	18.50	18.80
G 2	DN 50	○	10.0..1000	103.63	LABO-VHS-050...1000	1600	20.70	27.70	30.30
		●	15.0..1500	133.00	LABO-VHS-050...1500	2200	25.00	33.20	34.60
G 2 1/2	DN 65	●	25.0..2500	238.82	LABO-VHS-065...2500	3800	42.70	56.10	60.70

Wiring

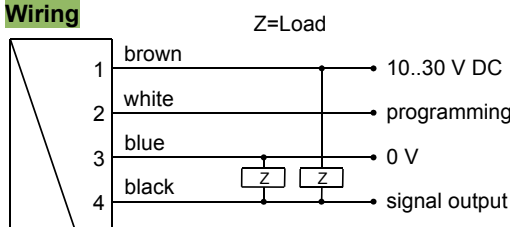

Connection example: PNP NPN

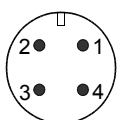

Before the electrical installation, it must be ensured that the supply voltage corresponds to the data sheet.

It is recommended to use shielded wiring. The push-pull output of the frequency or pulse output version can as desired be switched as a PNP or an NPN output.

Produktinformation

LABO-VHS-I / U / F / C

Dimensions

● = Standard ○ = Option

							VHS-...GAO...				VHS-...GAX...				
G	DN...range	x1	L1	ØD	SW	A	M	x2	B	C	L2	H	E	F	
G 1	025...0140	●	20	220	88	78	49.0	12	20	57.1	27.8	324	52	80	69
G 1¼	032...0350	●	22	285	103	-	55.0	14	22	66.7	31.6	381	48	94	77
G 1½	040...0550	○	24	332	122	-	58.8	16	24	79.4	36.5	448	58	106	89
	040...0800	●		340	138	-	66.5					456			
G 2	050...1000	○	33	396	155	-	71.0	20	35	96.8	44.4	544	74	135	116
	050...1500	●		405	168	-	77.3					553			
G 2½	065...2500	●	35	475	203	-	86.0	24	42	123.8	58.7	633	79	166	150

VHS-..GAO

VHS-..GAX

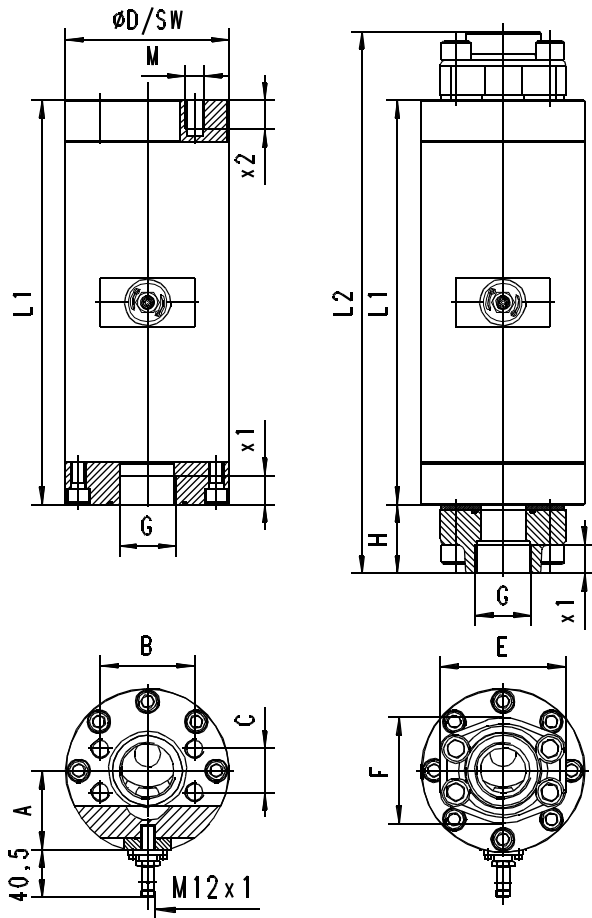

SAE adapter for convenient installation and for increased stability to pressure! (350 bar)

Handling and operation

Installation

Any flow direction is possible during installation. Ensure that pipework is clean. Flush before installation. A 30 µm mesh filter should be used.

The use of SAE flanges enables the sensor to be installed and removed more easily, and increases the stability to pressure to 350 bar for every connection material.

It is possible to replace the electronics during operation, and this presents no danger to the fitter. The sensor does not go into the flow space.

Note

The metering range end value can be programmed by the user via "teaching". Requirement for programmability must be stated when ordering, otherwise the device cannot be programmed.

The ECI-1 device configurator with associated software is available as a convenient option for programming all parameters by PC, and for adjustment. The teaching option is not available for the pulse output version.

Produktinformation

Operation and programming

The teaching process can be carried out by the user as follows:

- The flow rate to be set is applied to the device.
- Apply an impulse of at least 0.5 seconds and max. 2 seconds duration to pin 2 (e.g. via a bridge to the supply voltage or a pulse from the PLC), in order to accept the measured value.
- When teaching has been successfully completed, pin 2 should be connected to 0 V, so as to prevent unintended programming.

The devices have a yellow LED which flashes during the programming pulse. During operation, the LED serves as an display for operating voltage (for analog output) or of switching status (for frequency or pulse output).

In order to avoid the need to transit to an undesired operating status during the teach-in, the device can be provided ex-works with a teach-offset.

The teach-offset point is added to the currently measured value before saving. The offset point can be positive or negative. *Example: The end of the metering range should be set to 80 %. However, only 60 % can be achieved without problem. In this case, the device would be ordered with a "teach-offset" of +20%.. At 60 % in the process, a value of 80 % would then be stored during "teaching". If necessary, a far greater number of parameters can also be programmed using the ECI-1 device configurator.*

Ordering code

VHS - 1. 2. 3. 4. 5. 6. 7. 8. **G** **A** **E**

LABO - VHS - 9. 10. 11. 12. 13. **S**

○=Option

1. Nominal width								
025	DN 25 - G 1							
032	DN 32 - G 1 ¹ / ₄							
040	DN 40 - G 1 ¹ / ₂							
050	DN 50 - G 2							
065	DN 65 - G 2 ¹ / ₂							
2. Process connection								
G	female thread							
3. Connection material								
A	AL connection, anodised (160 bar, in combination with SAE flange: 350 bar)							
S	<input type="radio"/> Connection, steel (350 bar)							
4. Additional flange								
X	SAE flange, steel (350 bar)							
O	no SAE flange (pressure resistance depends on the connection material)							
5. Body material								
A	anodised aluminium							
6. Metering range								
0140	1.4.. 140 l/min							●
0350	3.5.. 350 l/min							●
0550	<input type="radio"/> 5.5.. 550 l/min							●
0800	8.0.. 800 l/min							●
1000	<input type="radio"/> 10.0..1000 l/min							●
1500	15.0..1500 l/min							●
2500	25.0..2500 l/min							●
7. Seal material								
N	NBR							
V	<input type="radio"/> FKM							
8. Connection for								
E	electronics							
9. For nominal width								
025	DN 25 - G 1							●
032	DN 32 - G 1 ¹ / ₄							●
040	DN 40 - G 1 ¹ / ₂							●
050	DN 50 - G 2							●
065	DN 65 - G 2 ¹ / ₂							●
10. Signal output								
I	current output 4..20 mA							
U	voltage output 0..10 V							
F	frequency output							
C	pulse output							
11. Programming								
N	cannot be programmed (no teaching)							
P	<input type="radio"/> programmable (teaching possible)							
12. Electrical connection								
S	for round plug connector M12x1, 4-pole							
13. Optional								
H	<input type="radio"/> 150 °C with electronics separated by 30 cm							

Produktinformation

LABO-VHS-I / U / F / C

Required ordering information

For LABO-VHS-F:

Output frequency at full scale

 Hz

Maximum value: 2.000 Hz

For LABO-VHS-C:

For the pulse output version, the volume (with numerical value and unit) which will correspond to one pulse must be stated.

Volume per pulse (numerical value)

Volume per pulse (unit)

Options

Special range for analog output:

<= metering range (standard=metering range)

 l/min

Special range for frequency output:

<= metering range (standard=metering range)

 l/min

Power-On delay period (0..99 s)

(time after applying power during which the outputs are not activated or set to defined values)

 s

Further options available on request.

Accessories

- Cable/round plug connector (KB...) see additional information "Accessories"
- converter / counter OMNI-TA
- Device configurator ECI-1