

Product Information

**Flow Meter
UK-050**



- Frontal scale imprint
- Optionally valve

Characteristics

A float moves in a transparent conical measurement tube, relative to the flow. The position of the float depends on the volume flow (weight force versus resistance to flow), and indicates the flow rate on the scaled measurement tube.

Technical data

Switch	without	
Nominal width	DN 25	
Process connection	female thread 1 " NPT	
Metering range	1..3000 l/min	for details see table "Ranges"
Q_{max.}	to 4,000 l/min	
Tolerance	±2 % of full scale value	
Pressure resistance	PN 6 bar	
Medium temperature	-20..+65 °C	
Ambient temperature	-20..+65 °C	
Media	water, gases	
Electrical data	none	
Materials medium-contact	acrylic, 1.4305, CW614N, PVC, NBR	
Non-medium-contact materials	acrylic, PVC, CW614N valve: ABS, CW614N	
Weight	0.8 kg	
Installation location	vertical inwards flow from below	

Ranges

Medium water

The details in the table correspond to a vertical inwards flow from below.

Metering range	Q _{max.} recommended	Type
2 - 19 l/min	21 l/min	UK.-050GHW0019
4 - 36 l/min	44 l/min	UK.-050GHW0036
5 - 75 l/min	90 l/min	UK.-050GHW0075

Medium air

The details in the table correspond to a vertical inwards flow from below, with the medium at a temperature of 0 °C and a pre-pressure of 1.013 bar.

Metering range	Q _{max.} recommended	Type
100 - 700 NI/min	850 NI/min	UK.-050GHL0700
100 - 1400 NI/min	1700 NI/min	UK.-050GHL1400
400 - 3000 NI/min	4000 NI/min	UK.-050GHL3000

Dimensions

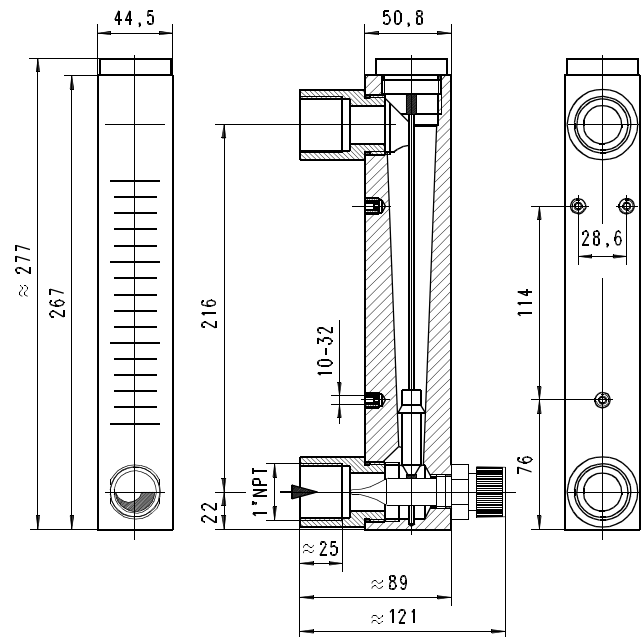

Product Information

Handling and operation

- Include straight calming section of 5 x DN in inlet and outlet
- If the media are dirty, install a filter

Ordering code

UK 1. 2. 3. 4. 5.

UK 050 G H

1. Valve		
-		without valve
V-		with valve
2. Series		
050		050, 1" FNPT
3. Process connection		
G		female thread
4. Connection material		
H		PVC
5. Display range H₂O for vertical inwards flow		
W0019		2 - 19 l/min
W0036		4 - 36 l/min
W0075		5 - 75 l/min
Display range air (0 °C 1.013 bar abs.) for vertical inwards flow		
L0700		100 - 700 NI/min
L1400		100 - 1400 NI/min
L3000		400 - 3000 NI/min

Options

- Metering ranges and special scales under defined operating pressures / temperatures

Ordering information

- Specify direction of flow, medium, and display range.
- For gases, state pressure (relative or absolute), temperature and medium (e.g. air) (request display range)