



## Operating manual

## Quick-Response Thermometer

as of version 4.0

# GMH 3211



- ☞ Please carefully read these instructions before use!
- ☞ Please consider the safety instructions!
- ☞ Please keep for future reference!



## Index

<b>1 GENERAL NOTE .....</b>	<b>2</b>
<b>2 SAFETY .....</b>	<b>3</b>
2.1 INTENDED USE .....	3
2.2 SAFETY SIGNS AND SYMBOLS .....	3
2.3 SAFETY GUIDELINES .....	4
<b>3 PRODUCT SPECIFICATION.....</b>	<b>5</b>
3.1 SCOPE OF DELIVERY .....	5
3.2 OPERATION AND MAINTENANCE ADVICE .....	5
<b>4 HANDLING .....</b>	<b>6</b>
4.1 DISPLAY .....	6
4.2 BASIC OPERATION.....	6
4.3 CONNECTIONS .....	6
4.4 POP-UP CLIP.....	7
<b>5 START OPERATION.....</b>	<b>7</b>
<b>6 DEVICE CONFIGURATION.....</b>	<b>8</b>
<b>7 REMARKS TO SPECIAL FEATURES .....</b>	<b>9</b>
7.1 BASE ADDRESS ('ADR.')	9
7.2 POWER OFF TIME.....	9
<b>8 OUTPUT.....</b>	<b>9</b>
8.1 SERIAL INTERFACE.....	9
<b>9 ADJUSTMENT .....</b>	<b>11</b>
9.1 ZERO DISPLACEMENT.....	11
9.2 SCALE CORRECTION.....	11
9.3 CORRECTION FOR SURFACE MEASURING.....	11
9.4 CALIBRATION SERVICES.....	11
<b>10 FAULT AND SYSTEM MESSAGES .....</b>	<b>12</b>
<b>11 RESHIPMENT AND DISPOSAL.....</b>	<b>12</b>
11.1 RESHIPMENT.....	12
11.2 DISPOSAL .....	13
11.3 DECOMMISSIONING .....	13
<b>12 SPECIFICATION.....</b>	<b>13</b>

## 1 General Note

Read this document carefully and get used to the operation of the device before you use it. Keep this document within easy reach near the device for consulting in case of doubt.

## 2 Safety

### 2.1 Intended Use

This device is designed for temperature measurement.

You can plug in a thermocouple sensor with Miniature-DIN-plug.

The device features a lot of useful features as for example hold, correction factor for surface measurement, interface etc.

Personnel which starts up, operates and maintains the device has to have sufficient knowledge of the measuring procedure and the meaning of the resulting measured values, this manual delivers a valuable help for this. The instructions of the manual have to be understood, regarded and followed.

To be sure that there's no risk arising due to misinterpretation of measured values, the operator must have further knowledge in case of doubt - the user is liable for any harm/damage resulting from misinterpretation due to insufficient knowledge.

The manufacturer will assume no liability or warranty in case of usage for other purpose than the intended one, ignoring this manual, operating by unqualified staff as well as unauthorized modifications to the device.

The safety requirements (see below) have to be observed.

The device must be used only according to its intended purpose and under suitable conditions.

Use the device carefully and according to its technical data (do not throw it, strike it, ...). Protect the device from dirt.

### 2.2 Safety signs and symbols

Warnings are labelled in this document with the followings signs:



**Caution!** This symbol warns of imminent danger, death, serious injuries and significant damage to property at non-observance.



**Attention!** This symbol warns of possible dangers or dangerous situations which can provoke damage to the device or environment at non-observance.









**Note!** This symbol point out processes which can indirectly influence operation, possibly cause incorrect measurement or provoke unforeseen reactions at non-observance.

## 2.3 Safety guidelines

This device has been designed and tested in accordance with the safety regulations for electronic devices.

However, its trouble-free operation and reliability cannot be guaranteed unless the standard safety measures and special safety advises given in this manual will be adhered to when using the device.

1. Trouble-free operation and reliability of the device can only be guaranteed if the device is not subjected to any other climatic conditions than those stated under chapter 12 Specification.
2.  If there is a risk whatsoever involved in running it, the device has to be switched off immediately and to be marked accordingly to avoid re-starting.  
Operator safety may be a risk if:
  - there is visible damage to the device
  - the device is not working as specified
  - the device has been stored under unsuitable conditions for a longer time. In case of doubt, please return device to manufacturer for repair or maintenance.
3.  Do not use these products as safety or emergency stop devices or in any other application where failure of the product could result in personal injury or material damage.  
Failure to comply with these instructions could result in death or serious injury and material damage.
4.  This device must not be used at potentially explosive areas! The usage of this device at potentially explosive areas increases danger of deflagration, explosion or fire due to sparking.
5.  This device is not constructed for use in medical applications.
6.  This device must not be run with a defective or damaged power supply unit. Danger to life due to electrical shock!
7.  Temperature sensor:  
There is a risk of stitch injury by using insertion probs. When measuring high temperatures there is a risk of burn, also due to residual heat of the sensor tube.
8.  Consider when measuring in food:  
The device housing is not construed for the permanent contact with food.  
Keep in mind to use temperature-probes witch are suitable for the use in food only.

## 3 Product Specification

### 3.1 Scope of delivery

The scope of supply includes:

- Device with battery
- Operating manual

### 3.2 Operation and maintenance advice

- **Battery operation:**

If 'bAt' is shown in the lower display the battery has been used up and needs to be replaced. However, the device will operate correctly for a certain time. If 'bAt' is shown in the upper display the voltage is too low to operate the device; the battery has been completely used up.



***The battery has to be taken out, when storing device above 50 °C. We recommend taking out battery if device is not used for a longer period of time.***

***After recommissioning the real-time clock has to be set again.***

- **Mains operation with power supply**



When using a power supply please note that operating voltage has to be 10.5 to 12 V DC.

Do not apply overvoltage!! Cheap 12V-power supplies often have excessive no-load voltage.

We, therefore, recommend using regulated voltage power supplies.

Trouble-free operation is guaranteed by our power supply GNG10/3000.

Prior to connecting the power supply to the mains, make sure that the operating voltage stated at the power supply is identical to the mains voltage.

- Treat device and sensor carefully. Use only in accordance with above specification. (do not throw, hit against etc.). Protect plug and socket from soiling.
- Connecting/changing sensors



To disconnect thermocouple sensor plug do not pull at the cable but at the plug

**Selection of types of thermocouples:** Prior to carrying out a measurement make sure to check if device is set to the thermocouple type used (type is shown on the display shortly after unit has been switched on). Unless the correct thermocouple is set, temperature measurements will be incorrect!

## 4 Handling

### 4.1 Display

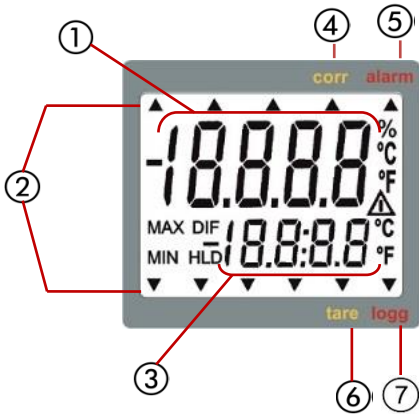

- 1 **Main display:** measuring value
- 2 Arrows show display options
- 3 **Secondary display:** display of min/max, hold  
**corr:** appears if offset-, scale correction or correction for surface measurement is <> state of delivery.
- 5 **alarm:** not in use
- 6 **tare:** not in use
- 7 **logg:** not in use

### 4.2 Basic Operation

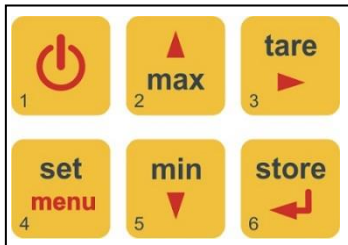

 **On / Off**

 **min/max measuring:**  
 press short: shows the min./max. value  
 press again: hides min./max. value  
 press 2 sec.: clears particular value

 *Not in use*

 **Set/Menu:**  
 press long: calling of configuration

**Store/Quit:**  
 press short: hold-function, the last measuring value will be held in the secondary display.  
 press again: hides the value

### 4.3 Connections

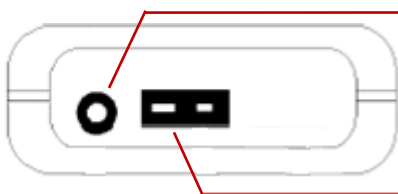

**Output:** Connection for optically isolated interface adapter

**Sensor Connection**

**Power supply:** the mains adapter socket is located at the left side of the device.

## 4.4 Pop-up clip

### Handling:

- Pull at label “open” in order to swing open the pop-up clip.
- Pull at label “open” again to swing open the pop-up clip further.

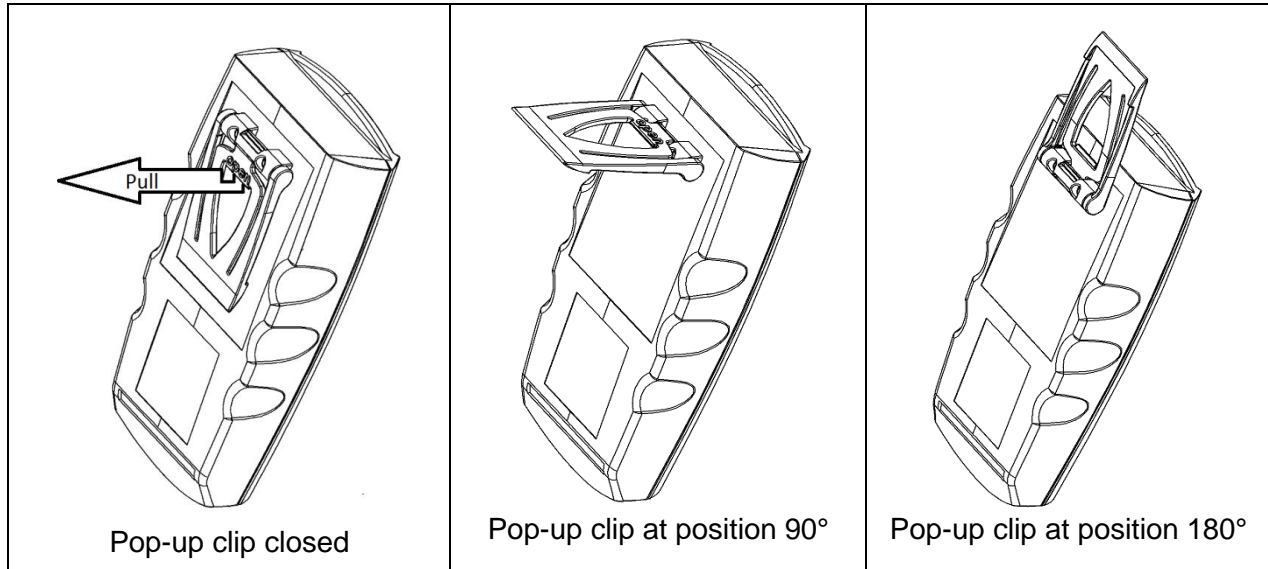

### Function:

- The device with a closed pop-up clip can be plainly laid onto a table or attached to a belt, etc.
- The device with pop-up clip at position 90° can be set up on a table, etc.
- The device with pop-up clip at position 180° can be suspended from a screw or the magnetic holder GMH 1300.

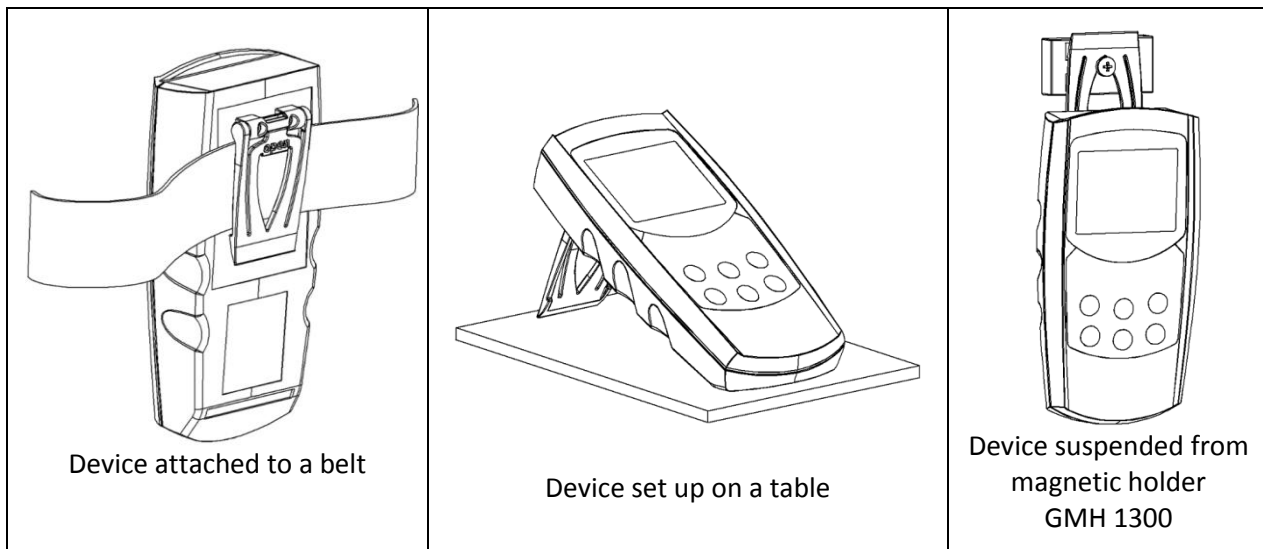

## 5 Start Operation

Connect sensor and turn on device via  key.

After segment test  the device displays some configuration:

- If the surface correction factor is adjusted, the display will show „SCF.x“ and its value shortly.

After that, the device is ready for measuring.

## 6 Device Configuration

To change device settings, press **Set** (key 4) for 2 seconds. This will call the configuration menu.

The parameters can be changed with **▲** (key 2) or **▼** (key 5).

Press **Set** again to go to the next setting.

**Store** (key 6) finishes the configuration and returns to standard measuring operation.

Parameter	Values	Meaning
MENU	KEY ▲ or ▼	
tYPE	ni.cr J S T N B E	<b>Selection Thermocouple:</b> Type K: NiCr-Ni Type J: Fe-CuNi Type S: Pt10Rh-Pt Type T: Cu-CuNi Type N: NiCrSi-NiSi Type B: Pt30Rh-Pt6Rh Type E: NiCr-CuNi
rES	0.1°	<b>Resolution:</b> 0,1°C or °F
	1°	<b>Resolution:</b> 1°C or °F
Unit	°C	Values in °C
	°F	Values in °F
P.oFF	1-120	<b>Auto Power Off</b> time in minutes
	oFF	Auto Power Off deactivated
Out	oFF	Function of the output: No output function, lowest power consumption
	SEr	Output is serial interface
Adr.	01,11..91	Base <b>address</b> of interface (if Out = SEr)
OFS.	-10.0°C..10.0°C or -18.0°F..10.0°F	The <b>offset of sensor</b> will be displaced by this value to compensate for deviations in the Sensor or in the measuring device.
	oFF:	Zero point displacement is deactivated (=0.0°)
SCL.	-5.00..5.00 %	The measuring <b>scale of sensor</b> will be changed by this factor [%] to compensate deviations of temperature probe or measuring device.
	oFF:	Correction factor is deactivated (=0.000)
SCF.	0.950..1.200	Correction value for surface measurement of sensor 1. (related to <b>ambient temperature</b> of the measuring device) See chapter 9.3 Correction for surface measuring
	oFF:	Surface correction factor is deactivated (=1.000)



## 7 Remarks To Special Features

### 7.1 Base Address ('Adr.')

Using the interface converter GRS3105 it is possible to connect several instruments to a single interface. As a precondition the base addresses of all devices must not be identical. In case several devices will be connected via one interface make sure to configure the base addresses accordingly.

### 7.2 Power off Time

If there won't be pressed any key and no interface communication takes place for the time of the power off time setting (P.Off), the device will be switched off automatically to save battery power.

If P.oFF = oFF then the automatic switch off is deactivated.

## 8 Output

**The output can be used as serial interface (for USB 3100, USB 3100 N, GRS 3100 or GRS 3105 interface adapters).**

If none of both is needed, we suggest to switch the output off, because battery life then is extended.

### 8.1 Serial Interface

By means of the serial interface and a suitable electrically isolated interface adapter (USB 3100, USB 3100 N, GRS 3100 or GRS 3105) the device can be connected to a computer for data transfer.

With the GRS 3105 up to 5 devices of the GMH3xxx- series can be connected to one interface (see also manual of GRS 3105). As a precondition the base addresses of all devices must not be identical, make sure to configure the base addresses accordingly (refer menu point "Adr." in chapter 6).

To avoid transmission errors, there are several security checks implemented e.g. CRC.

The following standard software packages are available:

- **GSOFT3050:** Operation and read out of logger function, data display in diagrams and tables
- **GMHKonfig:** Software for a comfortable editing of the device
- **EBS 20M / 60M:** 20-/60-channel software to display the measuring values

In case you want to develop your own software, we offer a **GMH3000-development package** including:

- A universally applicable Windows functions library ('GMH3000.DLL') with documentation that can be used by the most programming languages. Suitable for Windows XP™, Windows Vista™, Windows 7™, Windows 8 / 8.1™, Windows 10™
- Programming examples Visual Studio 2010 (C#, C++ and VB) etc.

**The device has 1 channel:**

- Channel 1: current measuring value

*Note: The measuring - and display range values read back from the interface are always in the selected measurement unit!*

## Supported interface functions

Channel	Code	Function
1		
x	0	Read measurement value
x	3	Read system state
x	12	Read ID number
x	174	Delete min. value
x	175	Delete max. value
x	176	Read min measuring range
x	177	Read max measuring range
x	178	Read measuring range unit
x	179	Read measuring range decimal point
x	180	Read kind of measuring of sensor
x	194	Set display unit
x	195	Set decimal point in display
x	199	Read kind of measuring of display
x	200	Read min display range
x	201	Read max display range
x	202	Read display range - unit
x	204	Read display range - decimal point
x	208	Read # of channels
x	214	Read scale correction
x	215	Set scale correction
x	216	Read offset correction
x	217	Set offset correction
x	218	Read correction factor for surface measurement
x	219	write correction factor for surface measurement
x	240	Reset
x	254	Program version

## 9 Adjustment

### 9.1 Zero Displacement

A zero displacement can be carried out for the measured value:

$$\text{value displayed} = \text{value measured} - \text{offset}$$

Standard setting: 'off' = 0.0°, i.e. no zero displacement will be carried out. Together with the scale correction (see below) this factor is mainly used to compensate for sensor deviations. Input is in the display unit.

### 9.2 Scale Correction

This setting influences the scale of the measuring (factor is in %):

$$\text{displayed value} = \text{measured value} * (1 + \text{Scal}/100)$$

Standard setting: 'off' = 0.000, i.e. value is not corrected. Together with the zero displacement (see above) this factor is mainly used to compensate for sensor deviations.

### 9.3 Correction for surface measuring

The correction value refers to the temperature difference between the device- / ambient temperature and the temperature determined by the thermocouple.

$$\text{display} = \text{device temperature} + (\text{measured temperature} - \text{device temperature}) * \text{Corr}$$

Standard setting: 'off' = 1.000

This factor is used to compensate for losses of transfer in case of surface measurements, occurring if the object to be measured is extremely hot but will be cooled by lower ambient temperatures. The same can be true for sensors with a large mass. Unless 'off' is set, this value will be displayed shortly after the device is switched on; during operation it will be identified by means of the Corr-arrow in the display



### 9.4 Calibration Services

Calibration certificates – DKD-certificates – other certificates:

If device should be certificated for its accuracy, it is the best solution to return it to the manufacturer.

Only the manufacturer is capable to do efficient recalibration if necessary to get results of highest accuracy!

## 10 Fault and System Messages

Display	Meaning	What to do?
	Low battery power, device will only continue operation for a short period of time	Replace battery
	Battery empty	Replace battery
	Mains operation without battery: wrong voltage	Check power supply, replace it when necessary
	No sensor connected	Connect sensor
	Connected sensor or device defective	If 2nd sensor available, check if device is ok. Return defective device/sensor to manufacturer for repair
	Value extremely out of measuring range	Check: right thermocouple selected.
No display or confused characters, device does not react on keypress	Battery empty	Replace battery
	Mains operation: wrong voltage or polarity	Check power supply, replace it when necessary
	System error	Disconnect battery and power supplies, wait shortly, then reconnect
	Device defective	Return to manufacturer for repair
<b>Err.1</b>	Measured value above allowable range	Check: correct thermocouple selected. Temperature not within sensor range? -> measuring value too high!
	Sensor defective	Return to manufacturer for repair
<b>Err.2</b>	Measured value below allowable range	Check: correct thermocouple selected. Temperature not within sensor range? -> measuring value too low!
	Sensor defective	Return to manufacturer for repair
<b>Err.3</b>	Display range overflow	Check: value above 1999.9 -> too high to be displayed
<b>Err.4</b>	Display range underflow	Check: value below -1999.9 (Tara?) -> too low
<b>Er.11</b>	Value could not be calculated	A value, that is necessary for the calculation, is not available (no sensor) or faulty (over- / underflow)
	Calculation overflow happened	Choose different unit
<b>Err.7</b>	System error	Check allowed working temperature of the device Return to manufacturer for repair

## 11 Reshipment and disposal

### 11.1 Reshipment



All devices returned to the manufacturer have to be free of any residual of measuring media and other hazardous substances. Measuring residuals at housing or sensor may be a risk for persons or environment



Use an adequate transport package for reshipment, especially for fully functional devices. Please make sure that the device is protected in the package by enough packing materials.

## 11.2 Disposal



Dispose exhausted batteries at destined gathering places. The device must not be disposed in the unsorted municipal waste! Send the device directly to us (sufficiently stamped), considering the above if it should be disposed. We will dispose the device appropriate and environmentally sound.

Private user can return the device at the municipal collection points for small electrical appliances.

## 11.3 Decommissioning

When decommissioning, connections **must not** be in a condition that causes the connected evaluation electronics (e.g. interface) to trigger unexpected switching operations.

## 12 Specification

<b>Thermocouples:</b>	J, K, N, S, T, E, B	
<b>Resolution:</b>	0.1°C or 1°C	0.1°F or 1°F
<b>Measuring range:</b>		
<b>Type K (NiCr-Ni):</b>	-220.0 ... +1372.0 °C	-364.0 ... +2502.0 °F (*)
<b>Type J (Fe-CuNi):</b>	-200.0 ... +1100.0 °C	-328.0 ... +2021.0 °F (*)
<b>Type T (Cu-CuNi):</b>	-200.0 ... +400.0 °C	-328.0... +752.0 °F
<b>Type N (NiCrSi-NiSi):</b>	-200.0 ... +1300.0 °C	-328.0 ... +2372.0 °F (*)
<b>Type S (Pt10Rh-Pt):</b>	-50.0 ... +1768.0 °C	-58.0 ... +3215.0 °F (*)
<b>Type E (NiCr-CuNi):</b>	-60.0 ... +850.0 °C	-76.0 ... +1562.0 °F
<b>Type B (Pt30Rh-Pt6Rh):</b>	+300 ... +1750 °C	+572 ... +3182 °F (*)
	*) values via interface, the device displays up to 1999.9 °F	
<b>Accuracy:</b>	(for thermocouples acc. to DIN EN 60584) ±1digit (at nominal temperature ± 5K)	
<b>Type J, K, N, T, E:</b>	± (0.5 °C + 0.2 % of measured value)	
<b>Type S, B:</b>	± (0.8 °C + 0.4 % of measured value)	
<b>Temperature drift:</b>	0.01 %/K	
<b>Point of comparison:</b>	±0.3 °C	
<b>Nominal temperature:</b>	25 °C	
<b>Measuring rate:</b>	4 meas./sec	
<b>Sensor connection:</b>	connection socket for miniature DIN-plug type K	
<b>Display:</b>	Two 4 ½ digit LCDs (12.4 mm high and 7 mm high) for measuring values, and for min/ max memories, hold function, etc. as well as additional functional arrows.	
<b>Pushbuttons:</b>	6 membrane keys	

<b>Output:</b>	3.5 mm audio plug, stereo
Output function:	serial interface
Interface:	Serial interface (3.5mm jack) can be connected to USB or RS232 interface of a PC via electrically isolated interface adapter USB3100, USB 3100 N, GRS3100 or GRS3105 (see accessories).
<b>Power supply:</b>	9V battery (included in scope of supply) as well as additional d.c. connector (diameter of internal pin 1.9 mm) for external 10.5-12V direct voltage supply. (suitable power supply: GNG10/3000)
Power consumption:	approx. 1.0 mA (Output „out“ = off) approx. 1.4 mA (Output „out“ = ser)
Low battery warning:	' bAt '
Working conditions:	-25 ... +50 °C, 0 ... 95 %RH (not condensing)
Storage temperature:	-25 ... +70 °C
<b>Housing:</b>	impact-resistant ABS, membrane keyboard, transparent panel, Front side IP65
Dimensions:	142 x 71 x 26 mm (L x W x D)
Weight:	approx. 155 g
<b>EMC:</b>	The instruments confirm to following European Directives: 2014/30/EU EMC Directive 2011/65/EU RoHS Applied harmonized standards: EN 61326-1 : 2013 emissions level: class B emi immunity according to table 3 and A.1 Additional fault: <1%  EN 50581 : 2012