

Digital Voltmeter V9648

Measuring - and indicating range separate programmable

Features

- LED-Display 14.2 mm red
- Display range $\pm 9999(0)$ Digit
- Indicating range and decimal point programmable
- Measuring range programmable
- True RMS measurement (AC)
- Frequency range AC 15 ... 400 Hz
- Max. 4 outputs SPDT relay or transistor
- Isolated analog output
0/4 ... 20 mA and 0/2 ... 10 V DC
- Front protection IP655



DIN 96x48mm

General information

The Digital Voltmeter V9648 has been designed to measure DC and AC(TRMS) voltage signals.

Three basic models all are selectable and makes the possibility to measure voltages from 0... 30.00 mV up to 0 ... 999.9 V. Within a model the measurement range is free programmable. Measuring bipolar voltages is possible with basic models 1 and 2, for example -5 ... +5 V; or -10 ... +10 V in basic model 2. Additional a free programmable display range within $\pm 9999(0)$ digit can be assigned to a programmed voltage measurement range. This can be important, if the measured voltage is a degree for another physical dimension.

Short information

Programming	Parameters are programmed via front-side membrane keypad.
Measuring input	Basic model 1 and 2 offers measurement \pm DC (range always from negative to positive value) and AC voltage alternatively. Note: basic model 3 does not offer decoupling between AC and DC.
Alarm outputs	Switching performance min. or max., hysteresis, on-delay time and off-delay time are programmable in range from 1 s up to 9 h.
Digital filter	With activated digital filter the last 16 measured values will be averaged continuously and the result shown in the display.
Analog output	Proportional to the input signal an isolated analog output signal 0 ... 20 mA/0 ... 10 V DC or 4 ... 20 mA/2 ... 10 V DC can be generated. Output changed automatically from current signal to voltage signal depending on burden.

Technical data

Power supply

Supply voltage : 230 V AC $\pm 10\%$; 115 V AC $\pm 10\%$, 24 V AC $\pm 10\%$ or 24 V DC $\pm 15\%$
 Power consumption : max. 3.5 VA, with analog output 5 VA
 Operating temperature : -10 ... +55 °C
 Rated voltage : Model 1 + 2; 300 V AC acc. VDE 0110 between input/output/supply voltage
 Model 3; 1000 V between input/output, supply voltage
 Degree of pollution 2,

Over-voltage category : Model 1 + 2, category III
 Model 3, < 600 V category III, > 600 V category II

Test voltage : Model 1 + 2; 4 kV DC between input/output/supply voltage
 Model 3, 6 kV between input/output, supply voltage

CE - conformity : EN55022, EN60555, IEC61000-4-3/4/5/11/13

Input

Input resistance : Model 1 = 130 kOhm, Model 2 = 1.3 MOhm, Model 3 = 2.6 MOhm
 Overload : Model 1+2 = 300 V AC/DC; Model 3 = 1200 V AC/DC
 Accuracy : < 0.1 % ± 2 digit (DC); 0.5 % ± 2 digit (AC)
 Temperature coefficient : 0.05 %/K

Display : LED red, 14.2 mm

Display range : $\pm 9999(0)$ digit, leading zero suppression

Parameter display : LED 2-digit red, 7 mm (parameter - and output indicator)

Output

Relay : SPDT < 250 V AC < 250 VA < 2 A, < 300 V DC < 50 W < 2 A

Transistor : max. 35 V AC/DC/100 mA, short circuit protected

Analog output : 0/4 ... 20 mA burden $\leq 500 \Omega$; 0/2 ... 10 V burden $> 500 \Omega$, isolated
 Automatic output changing (burden dependent)

-Accuracy : 0.1 %; TK 0.01 %/K

Case : Panel case DIN 96x48 mm, material PA6-GF; UL94V-0

Dimensions : Front 96x48 mm, mounting depth 100 mm,

Weight : max. 390 g

Electrical connection : Clamp terminals, 2 mm² single wire, 1,5 mm² flexible wire, AWG14

Protection : Front IP65, terminals IP20, fingersafe acc. German BGV A3

Dimensions

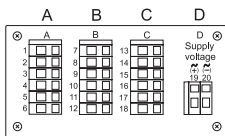
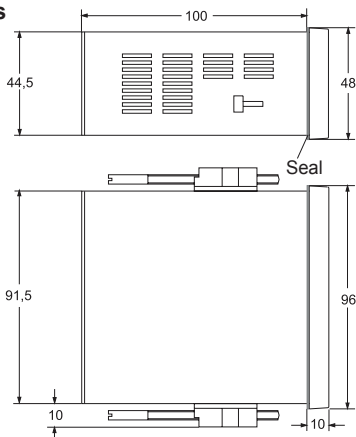

Position terminal strips

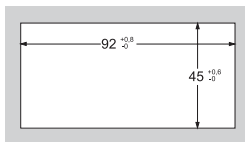

Panel cut-out
 acc. to DIN 43700-96x48

Connection diagrams

Terminal strip A

Input 0 ... 30 mV/1000 V AC/DC

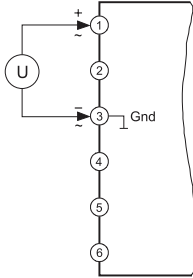

Terminal strip B (varies with version)

2 alarm outputs

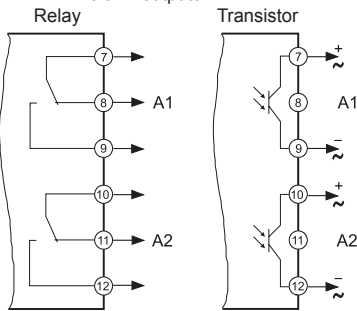

Terminal strip C (varies with version)

2 alarm outputs

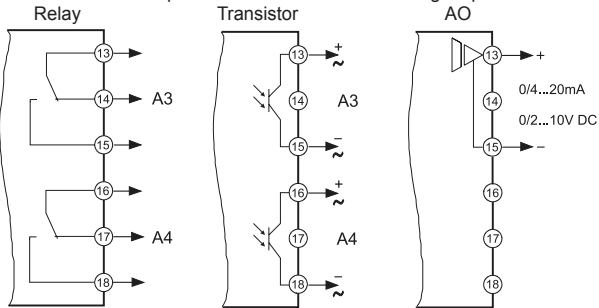

Terminal strip D supply voltage (varies with version)

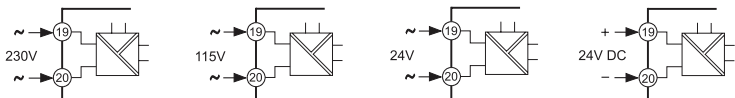

Controls and indicators

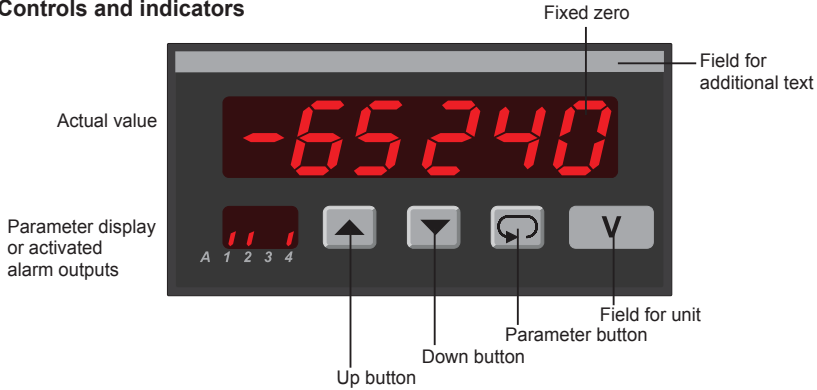

Description

Operating of the device is arranged in 2 levels. The requested parameter can be called by button . For selections within a parameter or for entering data, use buttons and .

After power-on, the device initializes itself. The display shows the message *init*.

After the initializing procedure the device is located in the **Working level**. Set points of the alarm outputs can be programmed if they are available.

Pressing the button for more than 2 seconds, activates the **Configuration level**. Now all the parameters which defines the function of the panelmeter can be programmed. E.g. the switching performance of the alarm outputs and the analog output.

After finishing the configuration or when no button was pushed for more than 2 minutes, the program returns to the working level. Leaving the configuration level is possible at any time by pressing the button for more than 2 seconds.

Parameter display as status indicator for the alarm outputs A1-A4.

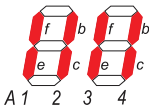

Segments f (A1/A3) and/or b (A2/A4) are flashing with 2 Hz, if the delay time is active.

Segments e (A1/A3) or c (A2/A4) are output indicators.

Error codes:

Display flashes The input signal is situated around more than 3 % outside of the programmed measuring range. The A/D- converter is over driving and the display flashes with appr. 1 Hz.

Error! EEPROM test. Reading this message, an error has been occurred. When pushing the button a copy of the EEPROM will be reloaded. The device works with the factory settings. Is this copy not working, please ship the panelmeter to factory for repair service.

Loc Parameter locked. See configuration page 7.

Start-up note: The device has to be configured, before it can be used => see page 6.

Notes to representation



Parameter is only displayed when configured















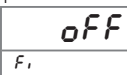



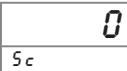



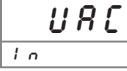



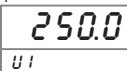



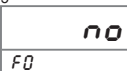



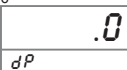

Parameter is only displayed when feature is included (see order code)

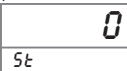



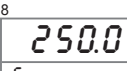







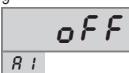









Please Note: All parameters can be called if they are not blocked by other programmed parameters and if they are available. **Factory settings** are shown in the display.

Working level

Button	Display	Description
		Actual value
		Output indication (only if installed and activated).
		Display brightness Permanent changing in the working level possible. Setting possible in 9 steps with buttons and .
		Note : only model 1 and 2.
		Max. peak reading
		Reset with buttons or , and at every power off.
		Min. peak reading
		Reset with buttons or , and at every power off.
		Setpoint output A1
		Setting possible from $5t \dots E n$ with buttons and . $5t$ (start value) ... $E n$ (end value)
		Note: Setpoints for alarm outputs A1 ... A4 have to be configured in the same way.

Configuration

Button	Display	Description (Display graphic shows factory settings)
 Press 2 s 	1  <i>F₁</i>	Digital filter <i>oFF</i> , <i>oN</i> Averaging of the last 16 measured values continuously. Selection with buttons  and  .
 	2  <i>S_c</i>	Display correction Setting possible from <i>-99(0)</i> ... <i>99(0)</i> Digit with buttons  and  .
 	3  <i>i_n</i>	Input signal <i>0</i> ... <i>U</i> DC voltage unipolar (measuring range 0 ... end value <i>U₁</i> , Param. 4) <i>-U</i> ... <i>U</i> DC voltage bipolar (measuring range e.g. -100 ... +100V) <i>UAC</i> AC voltage TRMS Selection with buttons  and  .
 	4  <i>U₁</i>	Measuring range (End value) Model 1 30.00 ... 4000 mV (floating point) Model 2 3.000 ... 250.0 V (floating point) Model 3 200.0 ... 999.9 V Selection with buttons  and  .
 	5  <i>F₀</i>	Fixed zero 0, e.g. 3690+0 <i>no</i> ; <i>YES</i> Selection with buttons  and  .
 	6  <i>dP</i>	Decimal places if <i>F₀</i> = <i>no</i> : <i>0. 0 .00 .000</i> if <i>F₀</i> = <i>YES</i> : <i>0. .00 .000 .0000</i> Selection with buttons  and  .
 	7  <i>S_t</i>	Start value for indicating range and analog output. Setting possible from <i>-9999</i> ... <i>9999</i> digit with buttons  and  . In case of modification a new configuration of the alarm outputs is necessary.
 	8  <i>E_n</i>	End value for indicating range and analog output. Setting from <i>-9999</i> ... <i>9999</i> digit with buttons  and  . In case of modification a new configuration of the alarm outputs is necessary. If <i>S_t</i> > <i>E_n</i> , the output works with a decreasing characteristic.
		

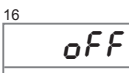
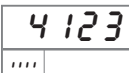
Button	Display	Description (Display graphic shows factory settings)
9 ↓  	 R1	Switching function alarm output A1 OFF, ONL (min), ONJ (max) If activated the start value will be loaded for set point. Selection with buttons ▲ and ▼.
10 ↓  	 R1	Setpoint alarm output A1 Setting possible from <i>S</i> (start value) ... <i>E</i> (end value) with buttons ▲ and ▼.
11 ↓  	 H1	Hysteresis alarm output A1 Setting possible from <i>!</i> ... <i>9999(0)</i> Digit with buttons ▲ and ▼.
12 ↓  	 t1	Switch-on delay time alarm output A1 Setting possible from <i>0.00.00</i> ... <i>9.00.00</i> (h.mm.ss) with buttons ▲ and ▼.
13 ↓  	 t1	Switch-off delay time alarm output A1 Setting possible from <i>0.00.00</i> ... <i>9.00.00</i> (h.mm.ss) with buttons ▲ and ▼. Note: The parameter settings for A2 ... A4 have to be configured in the same way.
14 ↓  	 R0	Analog output <i>0</i> - <i>20</i> mA (0 - 10 V DC) <i>4</i> - <i>20</i> mA (2 - 10 V DC) The switch-over from current to voltage output is load dependent (≤ 500 Ω = current output, > 500 Ω = voltage output). Selection with buttons ▲ and ▼.
15 ↓  	 C0	Code for factory settings
16 ↓  	 Lc	Programming lock OFF : no lock CONF : configuration level locked ALL : all parameters locked Selection with buttons ▲ and ▼.
		Return to the working level

Ordering code

V9648 - 1. - 2. - 3. - 4. - 5. - 6. - 7.

1. Terminal strip A

Display range and decimal place free programmable from:

1	0 ... 30.00 mV	to 0 ... 4000m V*	DC/AC _{TRMS}
2	0 ... 3.000 V	to 0 ... 250.0 V*	DC/AC _{TRMS}
*(includes e.g. ±5 V, ±10 V)			
3	0(5) ... 200.0 V	to 0(5) ... 999.9 V	DC/AC _{TRMS}

2. Terminal strip B

00	not installed		
2R	2 alarm outputs	relay	SPDT
2T	2 alarm outputs	transistor	

3. Terminal strip C

00	not installed		
2R	2 alarm outputs	relay	SPDT
2T	2 alarm outputs	transistor	
AO	Analog output	0/4 ... 20 mA or 0/2 ... 10 V DC	isolated

4. Terminal strip D supply voltage

0	230 V AC	± 10 %	50-60 Hz
1	115 V AC	± 10 %	50-60 Hz
4	24 V AC	± 10 %	50-60 Hz
5	24 V DC	± 15 %	

5. Option

00	without option
01	min- and max-peak-hold
07	display brightness programmable, only model 1 and 2

6. Unit (appears in the unit field)

7. Additional text (will be placed in the field for additional text, max. 3x90 mm HxW)