

# Temperature-Panelmeter T 9648

**Pt100 - Pt1000 - Thermocouple**

## Features

- LED-Display 14.2 mm red
- Measuring input:  
Pt100 -100.0 ... 600.0 °C\*  
Pt1000, -50.0 ... 200.0 °C\*  
Fe-CuNi(J), 0 ... 800.0 °C\*  
NiCr-Ni(K), 0 ... 1200 °C  
Pt10Rh-Pt(S), 0 ... 1600 °C  
\*switch off decimal point possible
- 2<sup>nd</sup> measuring input (only Pt100; Pt1000) for difference temperature, average value etc.
- Max. 4 outputs, SPDT relays or transistor
- Isolated analog output  
0/4 ... 20 mA and 0/2 ... 10 V DC
- Front protection IP65



## General

The Temperature-Panelmeter T9648 is suitable for measurement of temperatures in connection with RTD sensors Pt100, Pt1000 and thermocouples Fe-CuNi (J), NiCr Ni (K), Pt10Rh-Pt (S). Devices for other temperature sensors are available on request. The measuring input is isolated. The measuring range can be limited in the configuration level. It is identical with the range of the analog output.

## Short information

Programming	Parameters are programmed via front-side membrane keypad.
Alarm outputs	Switching performance min. or max., hysteresis, on-delay time and off-delay time are programmable in range from 1 s up to 9 h.
Digital filter	With activated digital filter last 16 measured values will be averaged continuously and the result shown in the display.
Analog output	Proportional to the input signal an isolated analog output signal 0 ... 20 mA/0 ... 10 V DC or 4 ... 20 mA/2 ... 10 V DC can be generated. Output changes automatically from current signal to voltage signal depending on burden.
2 <sup>nd</sup> measuring input*	The device can be offered with a 2 <sup>nd</sup> measuring input Pt100 or Pt1000 at terminal strip B. It is not possible to mix Pt100 or Pt1000 signals. In this way difference temperatures, average value, larger or smaller value can be displayed. Please ask for further information.

\*Note: no isolation between input 1 (terminal strip A) and 2<sup>nd</sup> measuring input

## Technical data

### Supply power

- Supply voltage : 230 V AC  $\pm 10\%$ ; 115 V AC  $\pm 10\%$ , 24 V AC  $\pm 10\%$  or 24 V DC  $\pm 15\%$   
 Power consumption : max. 3.5 VA, with analog output 5 VA  
 Operating temperature : -10 ... +55 °C  
 Rated voltage : 250 V  $\sim$  acc. VDE 0110 between input/output/supply voltage  
 Degree of pollution 2, over-voltage categoric III  
 Test voltage : 4 kV=, between input/output/supply voltage  
 Ⓢ - conformity : EN55022, EN60555, IEC61000-4-3/4/5/11/13

### Input

- Pt100 / Pt1000 : -100 ... 600 °C/-50 ... 200 °C  
 -Accuracy : Pt100 and Pt1000 < 0.1 %  $\pm 2$  Digit, max. 100 Ohm line resistant  
 Thermocouples : Fe-CuNi (J) 0 ... 800 °C, NiCr-Ni (K) 0 ... 1200 °C and Pt10Rh-Pt (S) 0 ... 1600 °C  
 reference junction compensation inserted.  
 -Accuracy : < 0.1 %  $\pm 2$  digit with compensating cable  
 Temperature coefficient : 0.004

### Display

- : LED red, 14.2 mm  
 Display range :  $\pm 9999(0)$  digit, leading zero suppression.  
 Parameter display : LED 2-digit red, 7 mm (parameter - and output indicator)

### Output

- Relay : SPDT < 250 V AC < 250 VA < 2 A, < 300 V DC < 50 W < 2 A  
 Transistor : max. 35 V AC/DC max. 100mA, short circuit protected  
 Analog output : 0/4 ... 20 mA burden  $\leq 500 \Omega$ ; 0/2 ... 10 V burden  $> 500 \Omega$ , isolated  
 Automatic output changing (burden dependent)  
 -Accuracy : 0.1%; TK 0.01%/K

### Panel case

- : DIN 96x48 mm, material PA6-GF; UL94V-0  
 Dimensions : Front 96x48 mm, mounting depth 100 mm  
 Weight : max. 390 g  
 Electrical connection : Clamp terminals, 2 mm<sup>2</sup> single wire, 1.5 mm<sup>2</sup> flexible wire, AWG14  
 Protection : Front IP65, terminals IP20, fingersafe acc. German BGV A3

## Dimensions

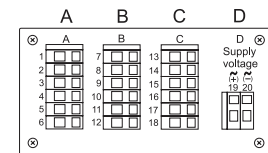
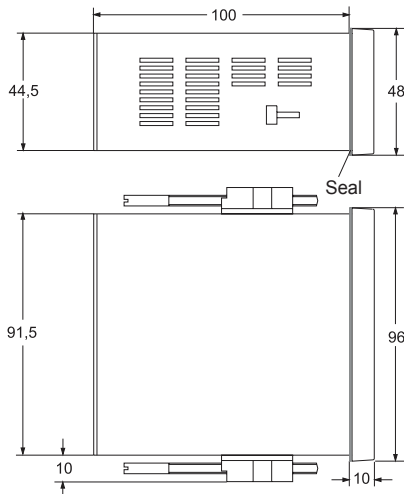

Terminal strip position

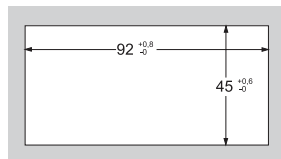

Panel cut-out acc. to  
 DIN 43700-96x48

## Connection diagrams

### Terminal strip A (varies with versions)

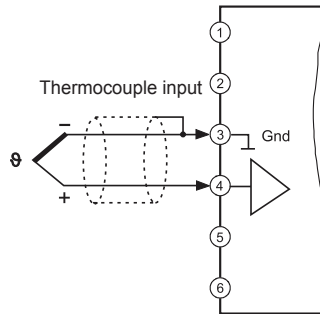
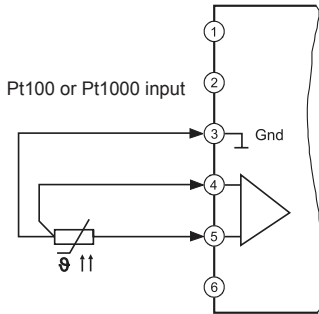

### Terminal strip B (varies with version)

2 alarm outputs

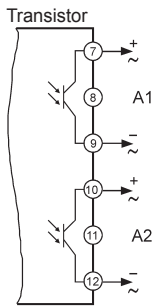
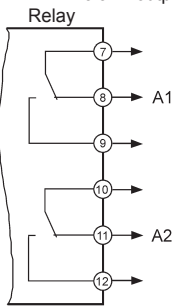

2. input  
Pt100 or Pt 1000

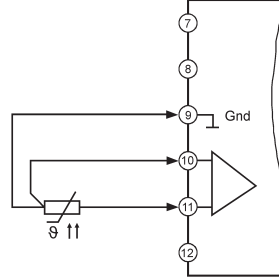

### Terminal strip C (varies with version)

2 alarm outputs

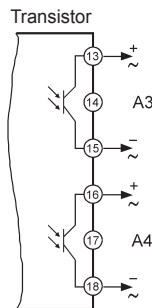
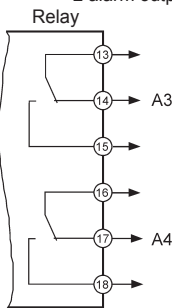

Analog output  
AO

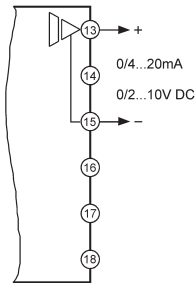

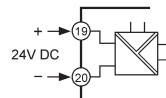
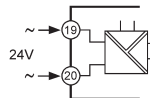
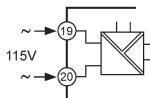
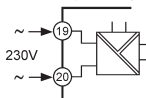

### Terminal strip D supply voltage (varies with version)

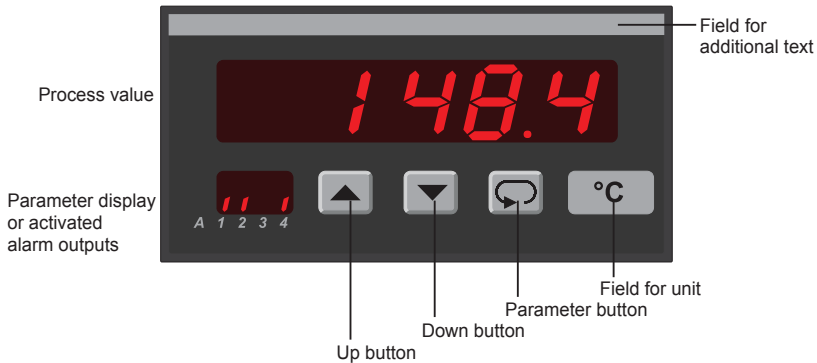

## Controls and indicators



## Description

Operation of the device is arranged in 2 levels. While programming, pressing the button  saves the current parameter and moves to the next programming step. For selection within a parameter or for entering data, use buttons  and .

After powering up, the device is located in the **Working level**. Set points of the alarm outputs can be preselected if available.

Pressing the button  for more than 2 seconds, activates the **Configuration level**. Now all the parameters which defines the function of the panelmeter can be programmed.

After finishing the configuration or when no button was pushed for more than 2 minutes, the program returns to the working level. Leaving the configuration level is possible at any time by pressing the button  for more than 2 seconds.

Parameter display as status indicator for the alarm outputs A1-A4.

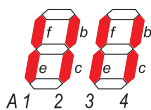

Segments f (A1 / A3) and/or b (A2 / A4) are flashing with 2 Hz, when delay time is active.

Segments e (A1 / A3) or c (A2 / A4) are output indicators.

### Error codes:

Display flashes      Overflow of the display range

*E r r o r*      EEPROM test. Reading this message, a program error has been occurred. When pushing the button  a copy of the EEPROM will be reloaded and the device will work with the factory settings. If this copy does not work, please ship the panelmeter to factory for repair service.

*L o c*      Programming lock active ( see configuration page 7)

### Start-up note:

Before setting into operation, the device must be configured for the intended use.

⇒ see page 6

### Notes to representation



Parameter is only displayed when configured



Parameter is only displayed when feature is included (see order code)

**Please Note:** All parameters can be called if they are not blocked by other programmed parameters and if they are available.

### Working level

Button

Display

Description

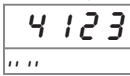

Actual value.

Alarm output indication  
(only if installed and activated).

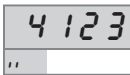

Display brightness (permanent changing possible)  
Setting possible in 9 steps with buttons ▲ and ▼ .

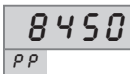

Display maximum reading.  
Reset with buttons ▲ or ▼ , or at every power off.



Display minimum reading.  
Reset with buttons ▲ or ▼ , or at every power off.

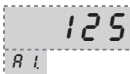

























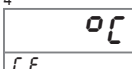



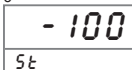

Setpoint output A1.  
Setting possible from  $S_t \dots E_n$  with buttons ▲ and ▼ .  
 $S_t$  (start value) ...  $E_n$  (end value)

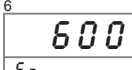



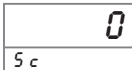





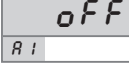

















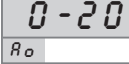

**Note:**  
Set points for alarm outputs A2 - A4 have to be configured in the same way.

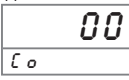
## Configuration

Button	Display	Description (Display graphic shows factory settings)
 Press 2 s	1  <i>OFF</i> <i>F</i>	Digitalfilter <i>oFF, on</i> Averaging of the last 16 measured values continuously. Selection with buttons  and  .
 	2  <i>FE Cu Ni</i> <i>In</i>	Input signal selection (only Thermocouple) <i>FE Cu Ni,</i> <i>Ni Cr Ni,</i> <i>Pt Rh Pt</i> Selection with button  and  . In case of modification a new configuration of the alarm outputs is necessary.
 	3  <i>dP</i> <i>0.</i> <i>0.</i>	Decimal point position (not with NiCr.Ni and PtRh.Pt) <i>0.</i> <i>0.</i> Selection with button  and  .
 	4  <i>°C</i> <i>°F</i>	Unit of the temperature <i>°C</i> <i>°F</i> Selection with button  and  .
 	5  <i>St</i>	Start value for indicating range and analog output Setting possible from min ... <i>En</i> with buttons  and  . min: Pt100 = -100; Pt1000 = -50 °C Fe-CuNi, NiCr-Ni, Pt10Rh-Pt = 0 °C In case of modification a new configuration of the alarm outputs is necessary.
 	6  <i>En</i>	End value for indicating range and analog output Setting possible from <i>St</i> ... max with buttons  and  . max: Pt100 = 600 °C; Pt1000 = 200 °C Fe-CuNi = 800 °C, NiCr-Ni = 1200 °C, Pt10Rh-Pt = 1600 °C In case of modification a new configuration of the alarm outputs is necessary.
 	7  <i>Sc</i>	Display correction Setting possible from -99 ... 99 Digit with buttons  and  .

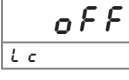
continue  
page 7

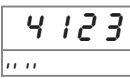
Button	Display	Description (Display graphic shows factory settings)
↓ 	8  R I	Switching performance output A1. Function <i>oFF</i> ; <i>o n L</i> (min); or <i>o n U</i> (max). If activated the start value will be loaded for set point. Selection with buttons ▲ and ▼.
	↓ 	
↓ 	9  R L	Set point output A1. Setting possible from <i>S t</i> (start value) ... <i>E n</i> (end value) with buttons ▲ and ▼.
	↓ 	
↓ 	10  H I	Hysteresis A1 Setting possible from <i>!</i> ... <i>9999</i> digit with buttons ▲ and ▼.
	↓ 	
↓ 	11  t i	Switch-on delay time output A1. Setting possible from <i>0.00.00</i> ... <i>9.00.00</i> (h.mm.ss) with buttons ▲ and ▼.
	↓ 	
↓ 	12  t i	Switch-off delay time output A1. Setting possible from <i>0.00.00</i> ... <i>9.00.00</i> (h.mm.ss) with buttons ▲ and ▼.
	Note: Switching performance and set points for alarm output A2 ... A4 has to be configured in the same way.	
↓ 	13  R o	Analog output. <i>0 - 2 0</i> mA (0 - 10 V DC) or <i>4 - 2 0</i> mA (2 - 10 V DC). Changing from current to voltage output is load-dependent ( $\leq 500 \Omega$ = current output, $> 500 \Omega$ = voltage output). Selection with buttons ▲ and ▼.
	↓ 	
↓ 	14  L o	Code for factory settings.
	↓ 	
↓ 	15  L c	Programming lock. <i>oFF</i> = no lock <i>L o n F.</i> = configuration level locked <i>R L L</i> = all parameters locked Selection with buttons ▲ and ▼.
	↓ 	
	 " "	Return to the working level

## Ordering code

T9648 -  1. -  2. -  3. -  4. -  5. -  6. -  7.

### 1. Terminal strip A

1	Input Pt100	-100.0 ... 600.0 °C
3	Input Pt1000	-50.0 ... 200.0 °C
5	Input thermocouple	
	Fe-CuNi (J)	0 ... 800.0 °C
	NiCr-Ni (K)	0 ... 1200 °C
	Pt10RH-Pt (S)	0 ... 1600 °C

### 2. Terminal strip B

00	not installed	
2R	2 alarm outputs	Relay
2T	2 alarm outputs	Transistor
T1*	2 <sup>nd</sup> input Pt100	-100.0 ... 600.0 °C
T3*	2 <sup>nd</sup> input Pt1000	-50.0 ... 200.0 °C

### 3. Terminal strip C

00	not installed	
2R	2 alarm outputs	Relay
2T	2 alarm outputs	Transistor
AO	analog output	0/4 ... 20 mA or 0/2 ... 10 V DC isolated

### 4. Terminal strip D supply voltage

0	230 V AC	± 10 %	50-60 Hz
1	115 V AC	± 10 %	50-60 Hz
4	24 V AC	± 10 %	50-60 Hz
5	24 V DC	± 15 %	

### 5. Options

00	without option
01	Min- und Max-value hold
02	Difference-, average value, larger value, smaller value
07	Display brightness programmable

### 6. Unit (appears in the unit field)

7. additional text (appears in the field for additional text  
 max. 3 x 90 mm, WxH)

### Attention:

\* in connection with terminal strip A, only Pt100 or Pt1000 are available  
 (Pt100 and Pt1000 cannot be mixed).

Note: not isolated to terminal strip A.