

Temperature-Meter T 1010

Pt100 - Pt1000

Features

- LED-Display 14.2 mm red
- Measuring input:
Pt100 -100.0 ... 600.0 °C*
Pt1000, -50.0 ... 200.0 °C*
*switch off decimal point possible
- Max. 2 outputs, SPDT relays
- Analog output 0/4 ... 20 mA or 0/2 ... 10 V DC
- Field case with snap lid, 2 x M16x1.5
other cable glands see option 09 or on request
- Protection IP65



General

The Temperature-Panelmeter T1010 is suitable for measurement of temperatures in connection with RTD sensors Pt100, Pt1000. Devices for other temperature sensors are available on request. The measuring input is isolated. The measuring range can be limited in the configuration level. It is identical with the range of the analog output.

Short information

Programming	Parameters are programmed via front-side membrane keypad.
Alarm outputs	Switching performance min. or max., hysteresis, on-delay time and off-delay time are programmable in range from 1 s up to 9 h.
Digital filter	With activated digital filter last 16 measured values will be averaged continuously and the result shown in the display.
Analog output	Proportional to the input signal an analog output signal 0 ... 20 mA/0 ... 10 V DC or 4 ... 20 mA/2 ... 10 V DC can be generated. Output changes automatically from current signal to voltage signal depending on burden.

Technical data

Supply power

Supply voltage	: 230 V AC ±10 %; 115 V AC ±10 %, 24 V AC ±10 % or 24 V DC ±15 %
Power consumption	: max. 3.5 VA
Operating temperature	: -20 ... +55 °C standard (extended temperature range on request)
Rated voltage	: 250 V \sim acc. VDE 0110 between input/output/supply voltage, over-voltage categoric III
Test voltage	: 4 kV=, between input/output/supply voltage
☐ – conformity	: EN55022, EN60555, IEC61000-4-3/4/5/11/13

Input

Pt100/Pt1000	: -100 ... 600 °C/-50 ... 200 °C
-Accuracy	: Pt100 and Pt1000 < 0.1 % ±2 Digit, max. 100 Ohm line resistance
Temperature coefficient	: 0.004 %/K

Display

	: LED red, 14.2 mm
Display range	: Input dependent , leading zero suppression.
Parameter display	: LED 2-digit red, 7 mm (parameter - and output indicator)

Output

Relay	: SPDT < 250 V AC < 250 VA < 2 A, < 300 V DC < 50 W < 2 A
Analog output	: 0/4 ... 20 mA burden ≤500 Ω; 0/2 ... 10 V burden >500 Ω, isolated automatic output changing (burden dependent)
-Accuracy	: 0.1%; TK 0.01%/K

Field case

	: Case polyamide, with fibre-glass PA6-GF 15/15, keypad polyester
Dimensions	: see drawing
Weight	: max. 450 g
Electrical connection	: Clamp terminals, 2 mm ² single wire, 1.5 mm ² flexible wire, AWG14
Protection	: Case IP65, terminals IP20, fingersafe acc. German BGV A3

Dimensions

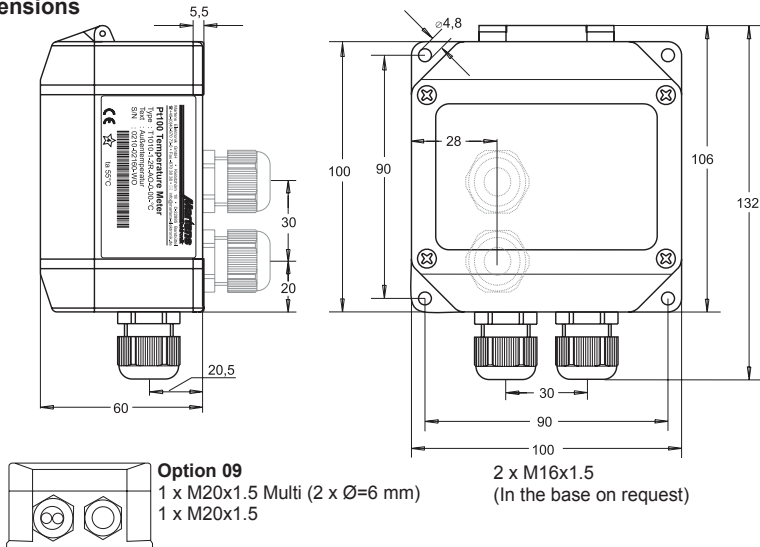

Legend (open lid)

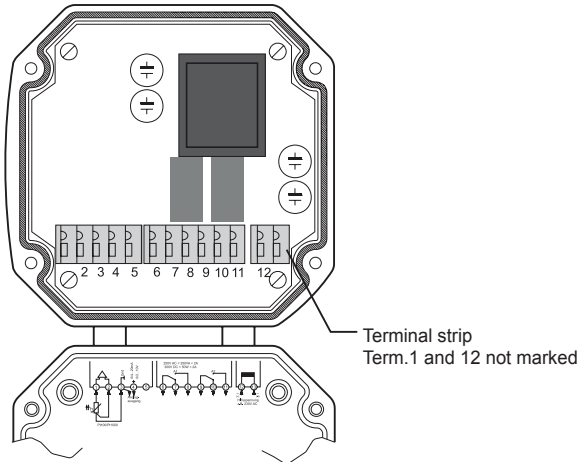

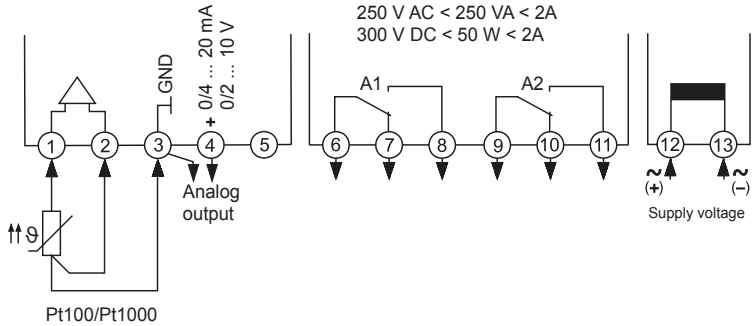

Connection diagram

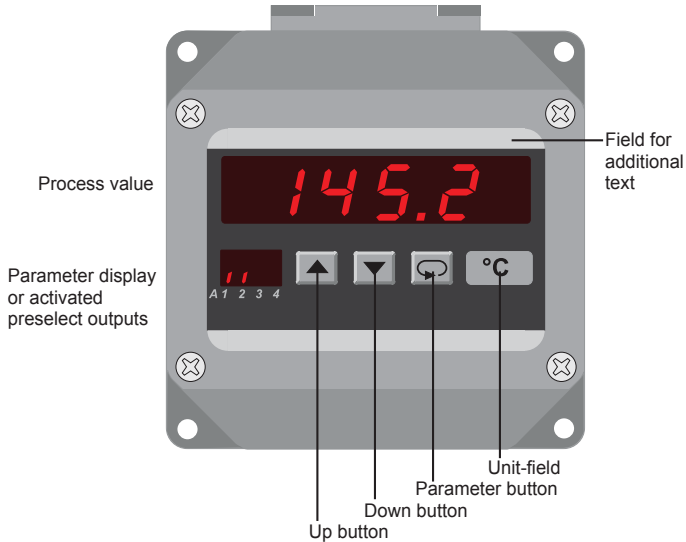

Controls and indicators



Description

Operation of the device is arranged in 2 levels. While programming, pressing the button  saves the current parameter and moves to the next programming step. For selection within a parameter or for entering data, use buttons  and .

After powering up, the device is located in the **Working level**. Set points of the alarm outputs can be preselected if available.

Pressing the button  for more than 2 seconds, activates the **Configuration level**. Now all the parameters which defines the function of the panelmeter can be programmed.

After finishing the configuration or when no button was pushed for more than 2 minutes, the program returns to the working level. Leaving the configuration level is possible at any time by pressing the button  for more than 2 seconds.

Parameter display as status indicator for the alarm outputs A1-A2.

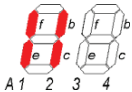

Segments f (A1) and b (A2) are flashing with 2 Hz, when delay time is active.

Segments e (A1) and c (A2) are output indicators.

Error codes:

Display flashes Overflow of the display range

Error 1 EEPROM test. Reading this message, a program error has been occurred. When pushing the button  a copy of the EEPROM will be reloaded and the device will work with the factory settings. If this copy does not work, please ship the panelmeter to factory for repair service.

Loc Programming lock active (see configuration page 7)

Start-up note:

Before setting into operation, the device must be configured for the intended use.

⇒ see page 6

Notes to representation



Parameter is only displayed when configured



Parameter is only displayed when feature is included (see order code)

Please Note: All parameters can be called if they are not blocked by other programmed parameters and if they are available.

Working level

Button

Display

Description

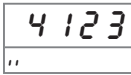

Actual value.

Alarm output indication
(only if installed and activated).

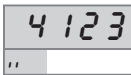

Display brightness (permanent changing possible)
Setting possible in 9 steps with buttons ▲ and ▼.



Display maximum reading.
Reset with buttons ▲ or ▼, or at every power off.



Display minimum reading.
Reset with buttons ▲ or ▼, or at every power off.

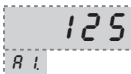

Setpoint output A1.
Setting possible from 5 ℓ ... E n with buttons ▲ and ▼.
5 ℓ (start value) ... E n (end value)

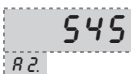

Setpoint output A2.
Setting possible from 5 ℓ ... E n with buttons ▲ and ▼.
5 ℓ (start value) ... E n (end value)



Configuration

Button **Display** **Description** (Display graphic shows factory settings)



Press
2 s

1

off
F

Digitalfilter
off, on Averaging of the last 16 measured values continuously.
Selection with buttons ▲ and ▼.



2

0
dP

Decimal point position
.0
0.
Selection with button ▲ and ▼.



In case of modification a new configuration of the alarm outputs is necessary.



3

°C
°F

Unit of the temperature
°C
°F
Selection with button ▲ and ▼.



4

-100
St

Start value for indicating range and analog output
Setting possible from min ... En with buttons ▲ and ▼.
min: Pt100 = -100; Pt1000 = -50 °C

In case of modification a new configuration of the alarm outputs is necessary.



5

600
En

End value for indicating range and analog output
Setting possible from St ... max with buttons ▲ and ▼.
max: Pt100 = 600 °C; Pt1000 = 200 °C

In case of modification a new configuration of the alarm outputs is necessary.













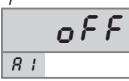





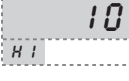





6

0
Sc

Display correction
Setting possible from -99 ... 99 Digit
with buttons ▲ and ▼.

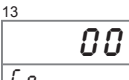

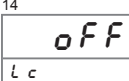
continue
page 7

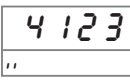
Button	Display	Description (Display graphic shows factory settings)
↓ 	7  R I	Switching performance output A1. Function <i>o F F</i> ; <i>o n L</i> (min); or <i>o n J</i> (max). If activated the start value will be loaded for set point. Selection with buttons ▲ and ▼.
		
↓ 	8  R L	Set point output A1. Setting possible from 5 k (start value) ... E n (end value) with buttons ▲ and ▼.
		
↓ 	9  H I	Hysteresis A1 Setting possible from ! ... 9999 digit with buttons ▲ and ▼.
		
↓ 	10  t i	Switch-on delay time output A1. Setting possible from 0.00.00 ... 9.00.00 (h.mm.ss) with buttons ▲ and ▼.
		
↓ 	11  t i	Switch-off delay time output A1. Setting possible from 0.00.00 ... 9.00.00 (h.mm.ss) with buttons ▲ and ▼.
		
		Note: Switching performance and set point for alarm output A2 has to be configured in the same way.
↓ 	12  R o	Analog output. 0 - 2 0 mA (0 - 10 V DC) or 4 - 2 0 mA (2 - 10 V DC). Changing from current to voltage output is load-dependent (≤ 500 Ω = current output, > 500 Ω = voltage output). Selection with buttons ▲ and ▼.
		
↓ 	13  L o	Code for factory settings.
		
↓ 	14  L c	Programming lock. <i>o F F</i> = no lock <i>L o n F.</i> = configuration level locked <i>R L L</i> = all parameters locked Selection with buttons ▲ and ▼.
		
	 "	Return to the working level

Ordering code

T1010 - 1. - 2. - 3. - 4. - 5. - 6. - 7.

1. Input

1	Input Pt100	-100.0 ... 600.0 °C
3	Input Pt1000	-50.0 ... 200.0 °C

2. Alarm outputs

00	not installed	
2R	2 alarm outputs	Relay

3. Analog output

00	not installed	
AO	analog output	0/4 ... 20 mA or 0/2 ... 10 V DC
	not isolated to the measuring input	

4. Supply voltage

0	230 V AC	± 10 %	50-60 Hz
1	115 V AC	± 10 %	50-60 Hz
4	24 V AC	± 10 %	50-60 Hz
5	24 V DC	± 15 %	

5. Options

00	without option
01	Min- und Max-value hold
07	Display brightness programmable
09	1 x M20x1.5 Multi (2 x Ø6 mm), 1 x M20x1.5

6. Unit (appears in the unit field)

7. Additional text (appears in the field for additional text max. 3 x 70 mm, WxH)