

Quantity-Meter M 9648

Integration of analog input signals 0/4 ... 20 mA and 0/2 ... 10 V DC

Features

- LED-Display 14.2 mm red
- Display range -99999 ... 999999 Digit
- Quantity value zero-voltage protected
- Display refreshing 4/s
- 2 measuring inputs for sum or differential measurement
- Programmable measuring constant
- Max. 4 alarm outputs, relay SPDT or transistor
- Isolated analog output 0/4 ... 20 mA or 0/2 ... 10 V DC, burden dependent
- Front protection IP65



General

The Quantity-Meter M9648 has been designed to measure quantities in connection with analog input signals (industry standard signals). Applications for example are measurement of total flow quantity (l,m³) or electric energy (kWh, MWh). The device can be adapted to a wide range of applications by programmable parameters.

Short information

Programming	Parameters are programmed via front-side membrane keypad
Constant of measuring	Value of the measuring range in relation to the analog signal from the connected transmitter, sensor or measuring device.
Alarm outputs	Switching performance of the alarm outputs is programmable as minimum or maximum function. Alarm indication via LEDs.
Analog output	Proportional to the display value an isolated analog output signal 0 ... 20 mA / 0 ... 10 V DC or 4 ... 20 mA/2 ... 10 V DC will be provided. Output changed automatically from current signal to voltage signal depending on burden.

Power supply

Supply voltage	: 230 V AC $\pm 10\%$; 115 V AC $\pm 10\%$, 24 V AC $\pm 10\%$ or 24 V DC $\pm 15\%$
Power consumption	: max. 3.5 VA, with analog output 5 VA
Operating temperature	: -10 ... +55 °C; 14 ... 131 °F
Rated voltage	: 250 V~ acc. to VDE 0110 between input/output/supply voltage degree of pollution 2, over-voltage categoric III
Test voltage	: 4 kV=, between input/output/supply voltage
CE-conformity	: EN55022, EN60555, IEC61000-4-3/4/5/11/13

Input

Current input	: $R_i = 10\ \Omega$ over-load 2-times; 4-times max. 5 s
Voltage input	: $R_i = 100\ k\Omega$ over-load max. 100 V
Reset input	: $R_i = 5\ k\Omega$ max. 30 V DC, level $U \leq 3\ V$ low $U \geq 10\ V$ high
-min. pulse width	: 80 ms
Accuracy	: 0.15 %
Temperature coefficient	: 0.005 %/K
Transmitter-supply	: U_0 approx. 24 V, R_i approx. 150 Ω , max. 50 mA (with 4 relay outputs max. 25 mA)

Display

Display range	: -99999...999999 Digit, leading zero suppression
Parameter display	: LED 2-digit red, 7 mm (parameter - and output indicator)

Output

Relay	: SPDT < 250 V AC < 250 VA < 2 A, < 300 V DC < 50 W < 2 A
Transistor	: max. 35V AC/DC max. 100mA, with short circuit protection
Analog output	: 0/4 ... 20 mA burden $\leq 500\ \Omega$; 0/2 ... 10 V burden $> 500\ \Omega$, isolated automatic output changing (burden dependent)
-Accuracy	: 0.1 %; TK 0.01 %/K

Panel case

Dimensions	: DIN 96x48 mm, material PA6-GF; UL94V-0
Weight	: see drawing below
Weight	: max. 390 g
Electrical connection	: clamp terminals, 2 mm ² single wire, 1,5 mm ² flexible wire, AWG14
Protection	: front IP65, terminals IP20, fingersafe acc. to German BGV A3

Dimensions

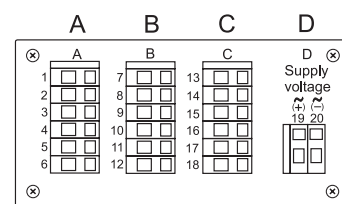
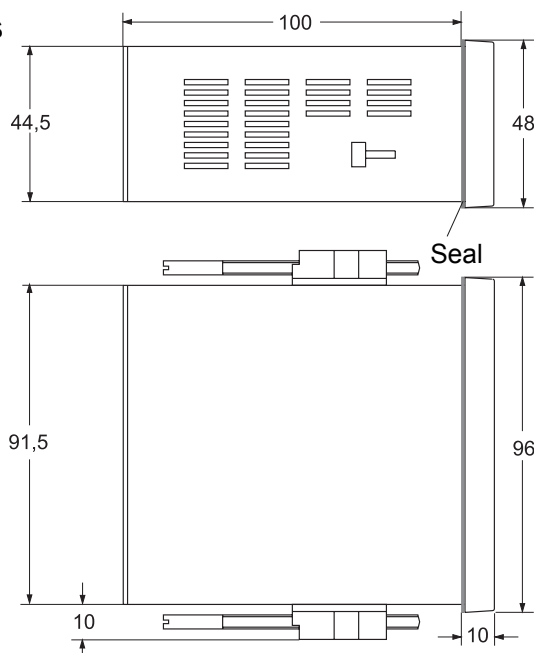

Terminal strip position

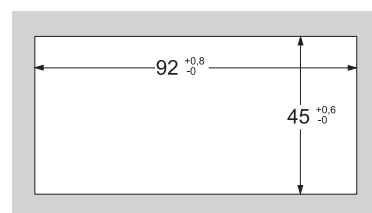

Panel cut-out acc. to
DIN 43700-96x48mm

Connection diagrams

Terminal strip A

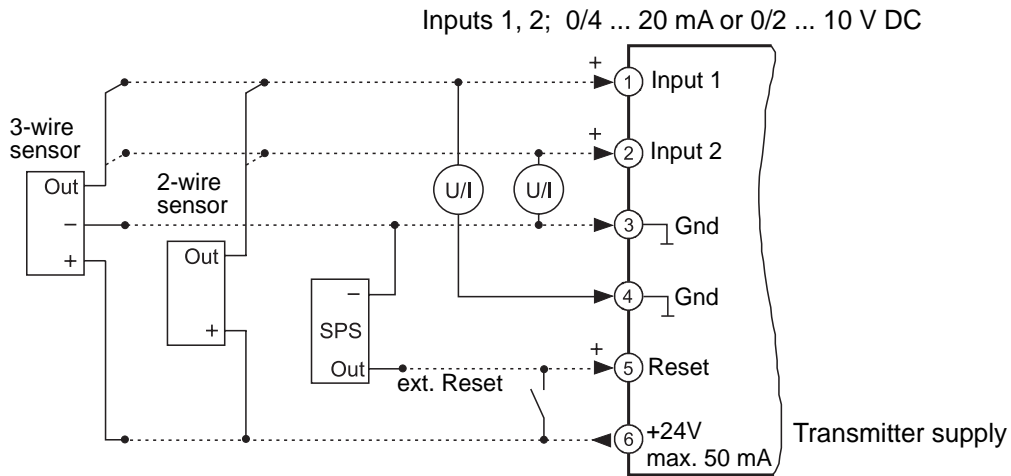

Terminal strip B (varies with version)

2 alarm outputs

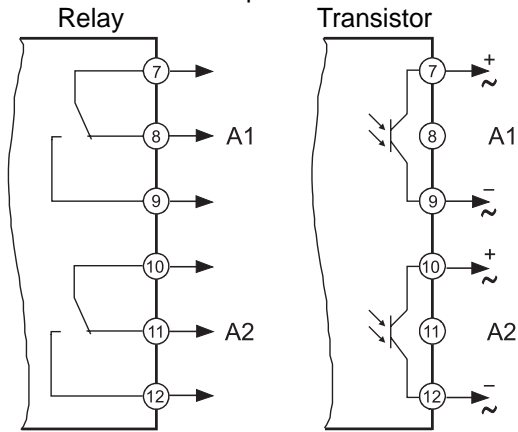

Terminal strip C (varies with version)

2 alarm outputs

Analogue output

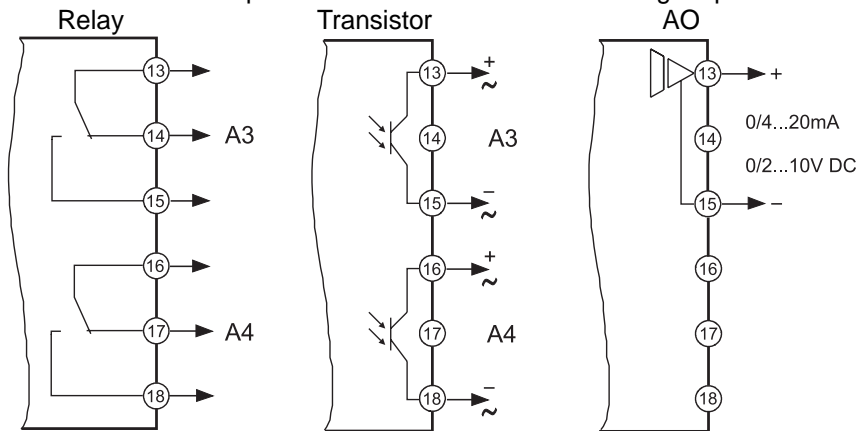

Terminal strip D supply voltage (varies with version)

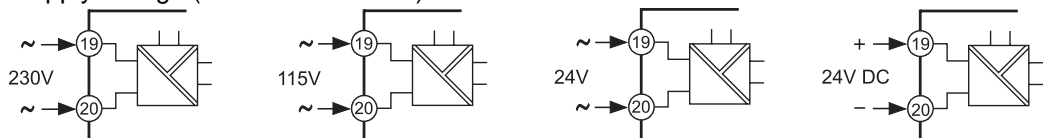

Controls and indicators

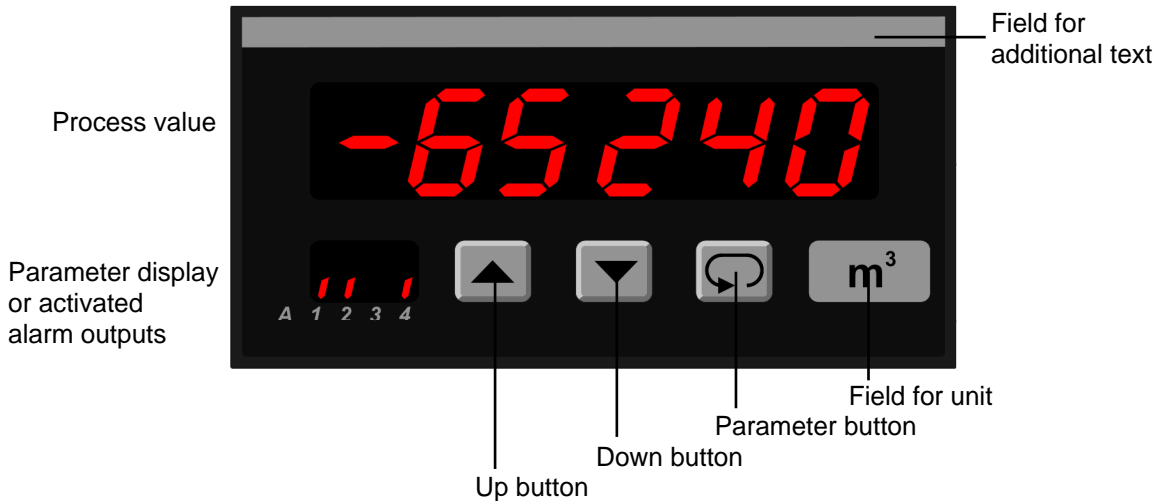

Description

Operating of the device is arranged in 2 levels. The requested parameter can be called by button . For selections within a parameter or for entering data, use buttons and .

Button combination:

+ 1 parameter back

After power-on, the device initializes itself. The display shows the message *init*.

After the initializing procedure the device is located in the **Working level**. Set points of the alarm outputs can be preselected and the display can be reset.

Pressing the button for more than 2 seconds, activates the **Configuration level**. Now all the parameters which define the function of the device can be programmed. E.g. the switching performance of the alarm outputs, measuring input, time unit and the analog output.

After finishing the configuration or when no button was pushed for more than 2 minutes, the program returns to the working level. Leaving the configuration level is possible at any time by pressing the button for more than 2 seconds.

Error messages:

Display flashes If the indicating range (-99999 ... 999999) for quantity measurement is over run or fallen short of the display flashes with 1 Hz. This state will be stored at power off and can only be changed with the reset (internal or external).

Error! EEPROM test. Reading this message, a parameter error is detected. By pressing the button a copy of the factory settings will be reloaded to the EEPROM. The device will work with the factory settings. If this copy does not work, please ship the panelmeter for factory repair.

Loc Parameter lock active. See configuration page 8.

Start-up note: The device has to be configured, before it can be used

⇒ see page 6

Notes to representation



Parameter is only displayed when configured







































Parameter is only displayed when feature is included (see order code)

Please Note: All parameters can be called if they are not blocked by other programmed parameters and if they are available. **Factory settings** are shown in the display.

Working level

Button	Display	Description
		Actual quantity value (zero-voltage safe stored) Output indication (only if installed and activated).
		Display input 1, actual time based quantity (no control with front buttons)
		Display input 2, actual time based quantity (no control with front buttons)
		Reset Pressing button for more than 3 s , the display will be reset to the programmed value. (⇒ page 7) (Feedback of the action with the display message <i>d o n E</i>).
		Setpoint output A1. Setting possible from -99999 ... 999999 Digit with buttons and .
		Set points for alarm outputs A1 - A4 have to be configured in the same way.

Configuration

Button	Display	Description (Display graphic shows factory settings)
 Press 2 s	<div style="border: 1px solid black; padding: 5px; text-align: center;"> ¹ 0-20 <i>n 1</i> </div>	Measuring signal input 1 (varies with version) <i>0 - 20</i> mA (0 - 10 V), <i>4 - 20</i> mA (2 - 10 V DC) Selection with buttons  and  .
	<div style="border: 1px solid black; padding: 5px; text-align: center;"> ² 0. <i>d 1</i> </div>	Decimals input 1 (for the best result choose number of decimals to get a 4-digit value of the measuring constant). <i>0. .0 .00 .000</i> Selection with buttons  and  . ⇒ page 9
		
	<div style="border: 1px solid black; padding: 5px; text-align: center;"> ³ 1000 <i>s 1</i> </div>	Sensor measuring constant input 1 Quantity per time unit at max. input signal (10 V or 20 mA) sign (-) subtraction. Setting possible from <i>-9999 ... -1000/ 0 / 1000 ... 9999</i> Digit with buttons  and  . ⇒ page 9
		
	<div style="border: 1px solid black; padding: 5px; text-align: center;"> ⁴ 00.0 <i>t 1</i> </div>	Time base input 1 <i>00.0</i> , minutes; <i>hour</i> , hours Selection with buttons  and  .
		
	<div style="border: 1px solid black; padding: 5px; text-align: center;"> ⁵ 0.0% <i>b 1</i> </div>	Dead band input 1 Setting possible from <i>0.0 ... 9.9</i> % of the input range with buttons  and  . ⇒ page 9
		
	<div style="border: 1px solid black; padding: 5px; text-align: center;"> ⁶ off <i>n 2</i> </div>	Measuring signal input 2 (varies with version) <i>off, 0 - 20</i> mA (0 - 10 V), <i>4 - 20</i> mA (2 - 10 V DC) Selection with buttons  and  .
		
	<div style="border: 1px dashed black; padding: 5px; text-align: center;"> ⁷ 0. <i>d 2</i> </div>	Decimals input 2 <i>0. .0 .00 .000</i> Selection with buttons  and  . ⇒ page 9
		
	<div style="border: 1px dashed black; padding: 5px; text-align: center;"> ⁸ 1000 <i>s 2</i> </div>	Sensor measuring constant input 2 Quantity per time unit at max. input signal (10 V or 20 mA) sign (-) subtraction. Setting possible from <i>-9999 ... -1000/ 0 / 1000 ... 9999</i> Digit with buttons  and  . ⇒ page 9

continue
page 7

Button Display Description (Display graphic shows factory settings)

↓  Time base input 2
00.00, minutes; *hour*, hours
 Selection with buttons ▲ and ▼.

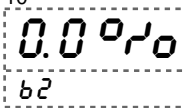

↓  Dead band input 2
 Setting possible from 00 ... 99 % of the input range
 with buttons ▲ and ▼. ⇒ page 9

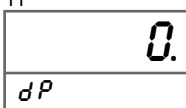

↓  Decimals of quantity value
0. *.0* *.00* *.000*
 Selection with buttons ▲ and ▼.

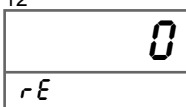

Note: Programmed values of analog output and alarm setpoints will be converted to the actual decimals automatically.

↓  Reset; start value after reset
 Setting possible from -99999 ... 999999 Digit
 with buttons ▲ and ▼. ⇒ page 9

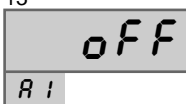

↓  Switching performance output A1.
 Function *OFF*; *ON L* (min); *ON U* (max)
 Selection with buttons ▲ and ▼.



↓  Alarm output A1
 Setpoint
 Setting possible from -99999 ... 999999 digit
 with buttons ▲ and ▼.













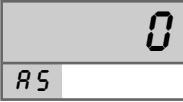

↓  Hysteresis A1
 Setting possible from 1 ... 999999 digit with buttons ▲ and ▼.

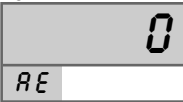
Note: The parameter settings for A2-A4 have to be configured the same way.

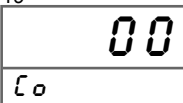

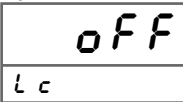
continue
page 8

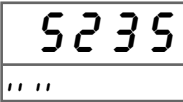
Button	Display	Description (Display graphic shows factory settings)
↓ 	16  R _o	Analog output. 0 - 20 mA (0 - 10 V DC) or 4 - 20 mA (2 - 10 V DC). Changing from current to voltage output is load-dependent (≤ 500Ω = current output, > 500 Ω = voltage output). Selection with buttons ▲ and ▼.
		
↓ 	17  R _S	Start value analog output Setting possible from -99999 ... 999999 digit with buttons ▲ and ▼.
		
↓ 	18  R _E	End value analog output Setting possible from -99999 ... 999999 digit with buttons ▲ and ▼. If R _S > R _E , the output works with a decreasing characteristic.
		
↓ 	19  L _o	Code for factory setting.
		
↓ 	20  L _c	Parameter lock oFF : no lock L _o nF. : configuration level locked R _l L : all parameters locked Selection with buttons ▲ and ▼.
		
	 " "	Back to the working level.

Parameter description

Programming examples for measuring constant:

51, 52 Measuring constant:

Value of the measuring range in relation to the analog signal from the connected transmitter, sensor or measuring device.

1. Flow through device 0 ... 10.5 l/min = 4...20 mA (sensor data)
 - ⇒ Input: 4-20
 - ⇒ Decimals: 2 (for 4-digit)
 - ⇒ Measuring constant: 10.50
 - ⇒ Time base: min
2. Flow through device 0 ... 400 m³/h = 4...20 mA (sensor data)
 - ⇒ Input: 4-20
 - ⇒ Decimals: 1 (for 4-digit)
 - ⇒ Measuring constant: 400.0
 - ⇒ Time base: hour
3. True power transmitter (with current transformer) 0 ... 60 kW = 0...20 mA (transmitter data)
 - ⇒ Input: 0-20
 - ⇒ Decimals: 2 (for 4-digit)
 - ⇒ Measuring constant: 60.00
 - ⇒ Time base: hour (electric power, always hour)

Programming example for dead band parameter:

b1, b2 Dead band:

Indicates, up to which percentage of the input signal is to be detected as invalid. For example it will prevent any measurement of the M9648, if the flow transmitter provides a leakage signal without any flow.

Flow through = 0

- ⇒ Input: measuring range 0 ... 10.5 l/min
- Working level display input 1 = 0.08 l/min ⇒ dead band 0.08 l/min = 0.76 %
(depends on the measuring constant 0-10.5 l/min)
- ⇒ Dead band: 0.8 %

Programming examples for reset parameter:

rE Start value after reset.

Display value after executed reset. Any value within the indicating range can be set. While reset signal is applied, no measurement of input signal is possible (status-controlled).

1. For filling a tank, $rE = 0$ should be programmed and measurement of filling operation can begin.
2. A filled tank with 15.000 litres of petrol, $rE = 15000$ should be programmed and measurement of emptying of operation can begin.
3. In case of electrical energy, $rE = 0$ should be programmed and measurement of the electrical work can begin.

Installation examples

Flow through-quantity measurement

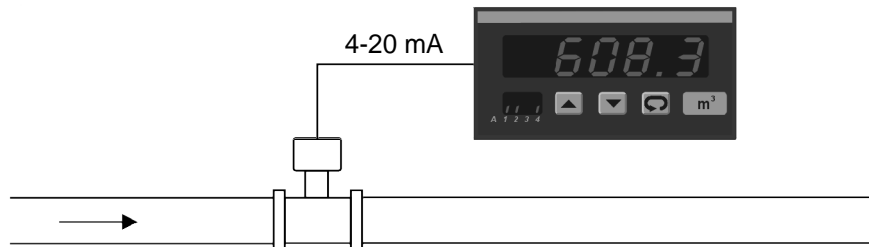

Note: If big quantities are to be measured with small run performance over a long period of time, it may be necessary to program the measuring constant of the flow sensor in m³/h. If sensor constant is specified in l/min, it must be converted to m³/h (e.g. 20 L/min = 1.200 m³/h). Then the display shows measured quantity in m³.

Example: Sensor constant 0 ... 14.8l/min = 4 ... 20 mA
new constant 0 ... 0.8880m³/h = 4 ... 20 mA

Total sum measurement of filling

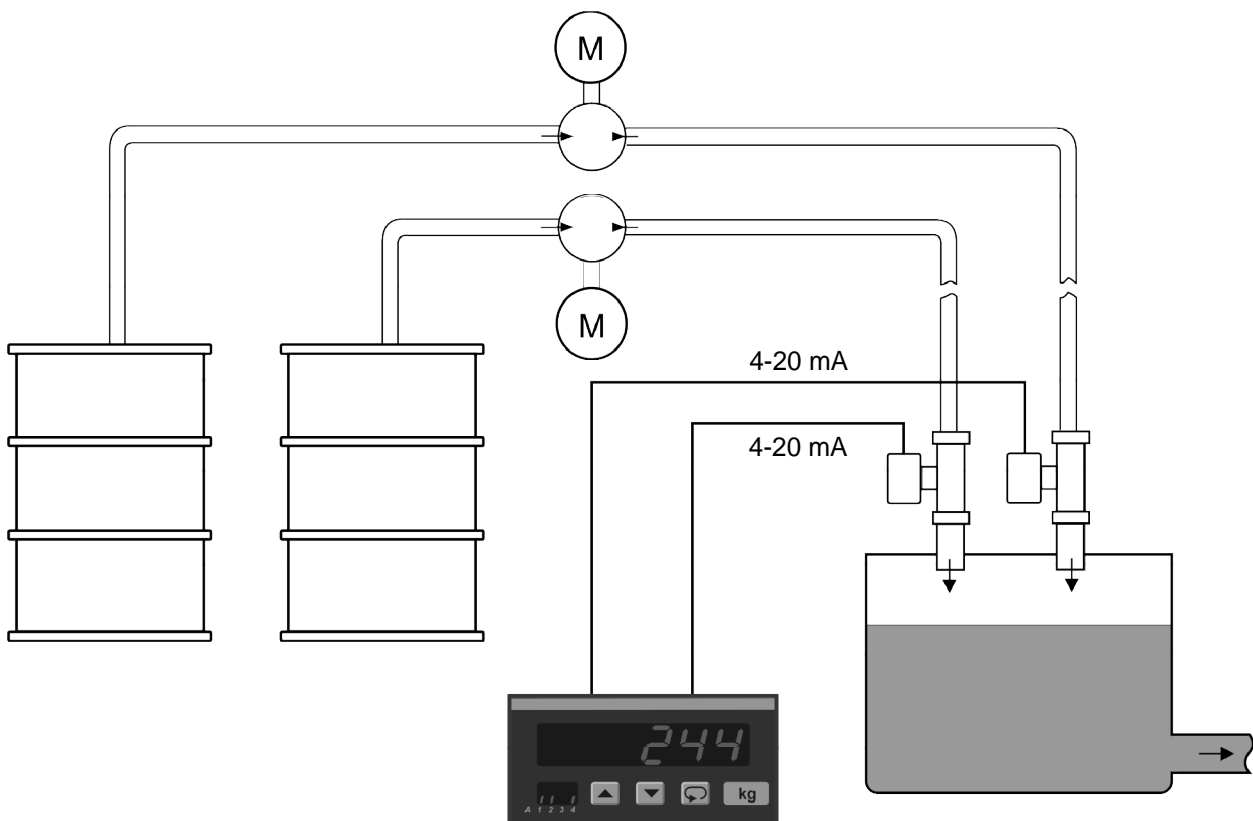

Total differential measurement of filling

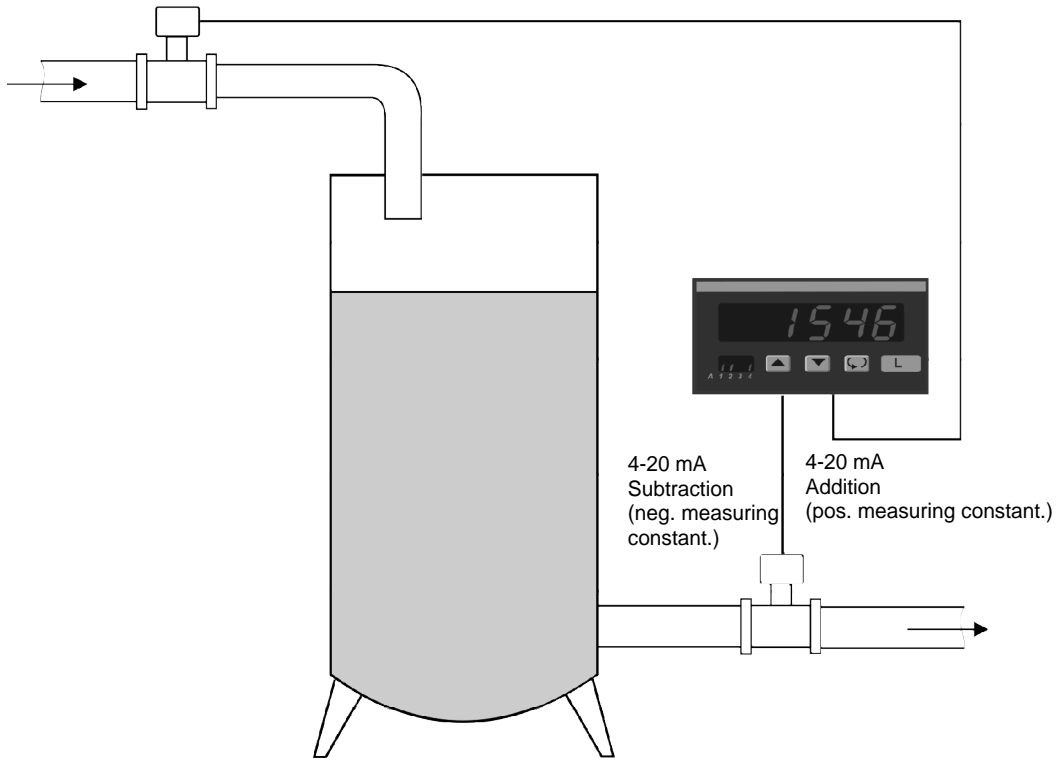

Measurement of the total electrical energy with an active power transmitter (e.g. WM500)

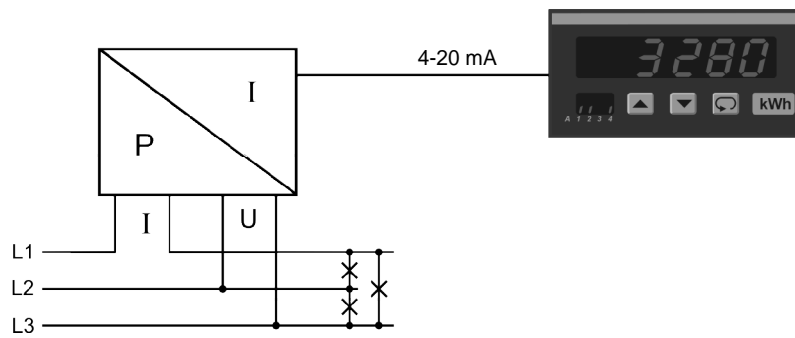

Ordering code

M9648 - 1. - 2. - 3. - 4. - 5. - 6. - 7.

1. Terminal strip A

- | | | |
|---|--------------------------|--|
| 1 | 2 inputs 0/4 ... 20mA | integrated transmitter supply 24V DC max. 50mA |
| 2 | 2 inputs 0/2 ... 10 V DC | integrated transmitter supply 24V DC max. 50mA |

2. Terminal strip B

- | | | |
|----|-----------------|------------|
| 00 | not installed | |
| 2R | 2 alarm outputs | relay |
| 2T | 2 alarm outputs | transistor |

3. Terminal strip C

- | | | |
|----|-----------------|--|
| 00 | not installed | |
| 2R | 2 alarm outputs | relay |
| 2T | 2 alarm outputs | transistor |
| AO | Analog output | 0/4 ... 20 mA or 0/2 ... 10 V DC
isolated |

4. Terminal strip D supply voltage

- | | | | |
|---|----------|--------|----------|
| 0 | 230 V AC | ± 10 % | 50-60 Hz |
| 1 | 115 V AC | ± 10 % | 50-60 Hz |
| 4 | 24 V AC | ± 10 % | 50-60 Hz |
| 5 | 24 V DC | ± 15 % | |

5. Option

- | | |
|----|----------------|
| 00 | without option |
|----|----------------|

6. Unit (on the panel front)

7. **Additional text** (on the additional text field on the panelmeter, maximum 3 x 90mm WxH)